

# HCVR-3

## Conventional Fire Alarm Releasing System

### Installation and Operation Manual



## **Underwriters Laboratories (UL)**

Fire Alarm Equipment

Hochiki America Corporation

The HCVR-3 series Releasing Fire Control Panel is suitable as follows:

- Local Signaling Unit, Cross Zone and Releasing
- Commercial protected-premises control unit
- Types of signaling services are SLC Class B, Style 4, NFPA 72 conventional IDC Class B and Style C or Class B, Style B, automatic fire alarm, manual fire alarm
- Non-coded Signaling
- Compatibility IDAXT0110

Install detectors with spacing as specified in section 90.19 of UL 864, 9th edition where units employing the multiple detector operation shall include guidelines for installing a minimum of two detectors in each protected space and to reduce the detector installation spacing to 0.7 times the linear spacing in accordance with National Fire Alarm Code, NFPA 72. Also reference 55.3.1 and 55.3.2 of UL 864, 9th edition for these detector spacing requirements.

## **NFPA**

Hochiki America Corporation

This product satisfies releasing operation under:

- Carbon dioxide extinguishing systems, NFPA 12
- Halon 1301 fire extinguishing systems, NFPA 12A
- Sprinkler systems, NFPA 13
- Water spray fixed systems for fire protection, NFPA 15
- Foam-water sprinkler and foam-water spray systems, NFPA 16
- Dry chemical extinguishing systems, NFPA 17
- Wet chemical extinguishing systems, NFPA 17A
- Water mist, NFPA 750
- Clean agent fire extinguishing systems, NFPA 2001

This page intentionally left blank.

Copyright© 20012 by Hochiki America Corporation  
All rights reserved

---



Hochiki America Corporation is a registered trademark.  
All other product or service names are the property of their respective owners.

**Hochiki America Corporation**  
**HCVR-3 Series - Conventional Fire Alarm Releasing System**  
**Installation and Operation Manual, HA-06-294, Version V02.10**

# Contents

---

## Section 1

### Introduction

<b>Using This Manual</b> .....	<b>2</b>
<b>Document Conventions</b> .....	<b>3</b>
Part Numbers .....	3
Writing styles .....	3
<b>If You Need Help</b> .....	<b>3</b>
<b>Contacting Hochiki America Technical Support</b> .....	<b>3</b>
RMA Returns Required .....	4
Warranty Returns .....	4
<b>Product Return Address</b> .....	<b>4</b>

## Section 2

### Overview

<b>Hardware Features</b> .....	<b>8</b>
Internal Power Supply .....	9
Power Outputs .....	9
Releasing Circuit .....	9
NAC Outputs .....	9
<b>Panel Controls and Indicators</b> .....	<b>10</b>
Controls .....	10
Indicators .....	12
<b>Field Terminals</b> .....	<b>16</b>
<b>General Installation Checklist</b> .....	<b>18</b>

## Section 3

### Installation

<b>Before You Begin</b> .....	<b>19</b>
<b>Determining System Current Draw</b> .....	<b>20</b>
Standby-Battery Capacity .....	20
Operating Constraints .....	20
<b>Mounting the Fire Control Panel</b> .....	<b>20</b>
Preparing .....	20
Removing the Fascia .....	21
Mounting .....	22

## Contents

---

<b>Separation of Circuits</b> .....	<b>22</b>
<b>AC Cabling</b> .....	<b>23</b>
<b>Standby-Battery Cabling</b> .....	<b>24</b>
<b>Field Cabling</b> .....	<b>26</b>
Detection Zones .....	26
Remote Control Inputs .....	28
Notification Appliance Circuit (NAC) .....	28
Releasing Circuit .....	31
Relay Outputs .....	33
Aux 24V .....	33
<b>Testing the Installation</b> .....	<b>34</b>
<b>Troubleshooting</b> .....	<b>35</b>

### Section 4

## Programming and Operating

<b>Programming the Fire Control Panel</b> .....	<b>38</b>
Access Level 3 .....	38
Configuration Codes .....	39
<b>Operating the Fire Control Panel</b> .....	<b>44</b>
Access Level 2 .....	44
Control Operation .....	45
Single Zone Fire Condition .....	46
Double Zone Fire Condition .....	46
Abort Function .....	47
Silence/Sound Alarms .....	47
Reset .....	47
Zone Trouble .....	48
NAC Trouble .....	48
Power Trouble .....	48
System Trouble .....	48
General Trouble .....	48
Lamp Test .....	48
Released Condition .....	48
Low Pressure Switch .....	48
Test mode .....	49

## Contents

---

Change mode .....	49
Extract fan .....	49
Disablements .....	49
Relay Operation .....	52
Calibrating the Releasing Circuit .....	53

### Section 5

## Maintenance and Repair

<b>Cleaning the External Cabinet and Door</b> .....	<b>54</b>
<b>Testing the Releasing System</b> .....	<b>54</b>
<b>Inspecting Batteries</b> .....	<b>54</b>
<b>Replacing Standby-Batteries</b> .....	<b>54</b>
Removing the Standby-Batteries .....	54
Installing the Standby-Batteries .....	55
<b>Replacing Fuses</b> .....	<b>55</b>
Battery Fuse .....	55
AC Input Fuse .....	56
<b>Replacing Cabinet Components</b> .....	<b>57</b>

### Section 6

## Supplementary Devices

<b>Status Display Units</b> .....	<b>58</b>
The J2 Jumper Connection .....	58
Abort Connections .....	60
Mode Input .....	61
Hold Input .....	61
Mode Select Key Switch .....	61
<b>Ancillary Board</b> .....	<b>61</b>
The J2 Jumper Connection .....	61
Relay Contacts .....	62
Connecting Power .....	63
24 VDC Terminals .....	63
Connecting Data .....	63
Power Fault (PF) .....	64
<b>Configuring Status Units and Ancillary Boards</b> .....	<b>64</b>
Adding Status Display Units and Ancillary Boards .....	65
Removing Status Display Units and Ancillary Boards .....	66

**Hochiki America Corporation**

**HCVR-3 Series - Conventional Fire Alarm Releasing System**

**Installation and Operation Manual, HA-06-294, Version V02.10**

## Contents

---

### Appendix A

## Specifications

<b>Electrical</b> .....	<b>.68</b>
AC Line Connection .....	.68
Power Supply .....	.68
System Power-Limitations .....	.68
Rechargeable Battery Circuit .....	.70
Ground Trouble Indication .....	.71
Field Wiring .....	.71
Initiating Device Circuit (IDC) Ratings .....	.73
Notification Appliance Circuit (NAC) .....	.73
Releasing Device Circuit .....	.74
AUX 24V .....	.76
Power Output Circuits .....	.76
Remote Control Inputs .....	.76
Status Unit Terminals .....	.77
Cabling .....	.77
<b>Supplementary Devices</b> .....	<b>.78</b>
Status Display Unit - HCVR-SDU .....	.78
Ancillary Board - HCVR-AB .....	.78
<b>Operating Environment</b> .....	<b>.79</b>
<b>Physical Specifications</b> .....	<b>.79</b>

### Appendix B

## Equipment List

<b>HCVR-3 Releasing Fire Control Panels</b> .....	<b>.80</b>
<b>Detectors</b> .....	<b>.80</b>
Hochiki .....	.80
<b>Supporting Equipment and Devices</b> .....	<b>.81</b>
<b>Replacement Parts</b> .....	<b>.82</b>
<b>Notification Appliances</b> .....	<b>.83</b>
Synchronization .....	.83
<b>Authorized Releasing Valves</b> .....	<b>.96</b>



## Contents

---

### Appendix C

#### Calculations

<b>Determining the Amp-Hour Rating</b> .....	<b>98</b>
Current-Loading .....	99
NAC Wiring Length .....	100
Releasing-Circuit Wiring Length .....	103

### Appendix D

#### Wiring Diagram

### Appendix E

#### Operating Instructions

<b>Inspecting Batteries</b> .....	<b>131</b>
<b>Replacing Standby-Batteries</b> .....	<b>131</b>
<b>Related Documentation</b> .....	<b>132</b>
<b>Emergency Contact</b> .....	<b>132</b>

### Appendix F

#### UL Compliance Label

### Appendix G

#### UL 864 Permitted Configurations

## Section 1 Introduction

This manual describes three-zone conventional models of the HCVR-3 Releasing Fire Control Panel. Models of the HCVR-3 Releasing Fire Control Panel include the red, 115 VAC model HCVR-3-R (115V), the red, 230 VAC model HCVR-3 (230V), the charcoal, 115 VAC model HCVR-3-C (115V) and the charcoal, 230 VAC model HCVR-3-C (230V).

This section describes:

- Using This Manual
- Related Documentation
- Document Conventions
- If You Need Help
- Contacting Hochiki America Corp. For Repair

The figure below illustrates the HCVR-3 Releasing Fire Control Panel:

**Figure 1-1**  
**HCVR-3 Releasing Fire Control Panel**



**Hochiki America Corporation**  
**HCVR-3 Series - Conventional Fire Alarm Releasing System**  
**Installation and Operation Manual, HA-06-294, Version V02.10**

## Using This Manual

The following sections provide instructions for installing, testing and troubleshooting the HCVR-3 Releasing Fire Control Panel:

- Section 1**     **Introduction** provides document conventions, the technical help-line, repair and return information.
  
- Section 2**     **Overview** provides a summary features of the HCVR-3 Releasing Fire Control Panel.
  
- Section 3**     **Installation** describes how to setup, install, test and troubleshoot the HCVR-3 Releasing Fire Control Panel.
  
- Section 4**     **Operation** describes how to initiate Access Level 2 or Access Level 3, identify Alarm Conditions, Controls and Indicators, understand Relay Contacts and how to Configure Ancillary Circuit Boards.
  
- Section 5**     **Maintenance and Repair** describes how to maintain and repair the HCVR-3 Releasing Fire Control Panel.
  
- Appendix A**   **Specifications** provides characteristics of the HCVR-3 Releasing Fire Control Panel.
  
- Appendix B**   **Equipment List** provides model numbers for HCVR-3 Releasing Fire Control Panels, loop devices, accessories, replacement parts and compatible Notification Appliances.
  
- Appendix C**   **Calculations** provides calculations for determining load capacity, battery rating, and wiring length of the HCVR-3 Releasing Fire Control Panel.
  
- Appendix D**   **Wiring Diagram** is a copy of the wiring diagram used for shipping with HCVR-3 Releasing Fire Control Panel.
  
- Appendix E**   **Operating Instructions** provides an overview of HCVR-3 Releasing Fire Control Panel status and control instructions.
  
- Appendix F**   **UL Compliance Label** is a copy of the compliance label applied to the cabinet door of the HCVR-3 Releasing Fire Control Panel
  
- Appendix G**   **UL Permitted Configurations** provides UL authorized codes for programming the HCVR-3 Releasing Fire Control Panel.

## Document Conventions

This document contains conventions for part numbers and writing style.

### Part Numbers

Part numbers are provided in Section 1, Appendix B and Appendix D of this manual. Refer to Appendix D, Door Label for a diagram summary of this manual. Refer to Appendix B, Equipment List for a complete list of part numbers required for completing this installation.

### Writing styles

Before you begin using the HCVR-3 Releasing Fire Control Panel, familiarize yourself with the stylistic conventions used in this manual:

***Italic type*** Denotes a displayed variable, a variable that you must type, or is used for emphasis.

**`Courier font`** Indicates text displayed on a computer screen.

## If You Need Help

If you need technical support contact Hochiki at (800) 845 - 6692 or e-mail [technicalsupport@hochiki.com](mailto:technicalsupport@hochiki.com). Technical support is available Monday through Friday, 7:00 AM to 5:00 PM, Pacific Standard Time.

## Contacting Hochiki America Technical Support

On-site technicians familiar with the product issue should contact Technical Support and include the:

- Product part number
- Purchase order number
- Product serial number
- Current function of the product
- Expected function of the product
- Installation of the product

## RMA Returns Required

A Return Material Authorization (RMA) must be assigned to all products returning to Hochiki America. Technical Support will assign an RMA to a returning product after recording information collected from the on-site technician. Hochiki America cannot not accept product-returns that do not include an accompanying RMA number.

An RMA number is assigned when:

- A product issue is acknowledged by a Hochiki America's Technical Support representative
- A product was damaged during shipping
- An incorrect product was shipped
- An order was placed using an incorrect part number \*
- An order was placed using an incorrect part quantity \*
- An order is no longer required \*

\* *Restocking fees may apply.*

## Warranty Returns

Technical Support can replace a defective product when the original purchase is within the warranty period defined in the sales contract. Check your sales-contract for more information or contact your Hochiki America's sales representative about the warranty period described in your sales-contract or terms and condition.

Warranty products that have been placed in service will be repaired or replaced by Hochiki America.

Warranty products that have *not* been placed in service will be returned to Hochiki America stock and an equivalent credit will be provided to the contractor.

## Product Return Address

Prominently display the RMA number on all packages sent to Hochiki America Corporation for return.

Ship all return products to:

Attention: RMA # \_\_\_\_\_

Hochiki America Corporation

7051 Village Drive, Suite 100

Buena Park, CA 90621

This page intentionally left blank.

## Section 2 Overview

The HCVR-3 Releasing Fire Control Panel is a conventional fire control panel and releasing system. The fire control panel provides connections for Detection Zones, Notification Appliance Circuits (NACs), Releasing Circuits, Relay Outputs, Status Units and AUX 24 V power.

Models of the HCVR-3 Releasing Fire Control Panel provide 115 VAC or 230 VAC operation in modes for regulated and special application environments.

The figure below illustrates Class B, Style C field wiring terminations of the HCVR-3 Releasing Fire Control Panel:

**Figure 2-1  
Field Wiring Terminations**

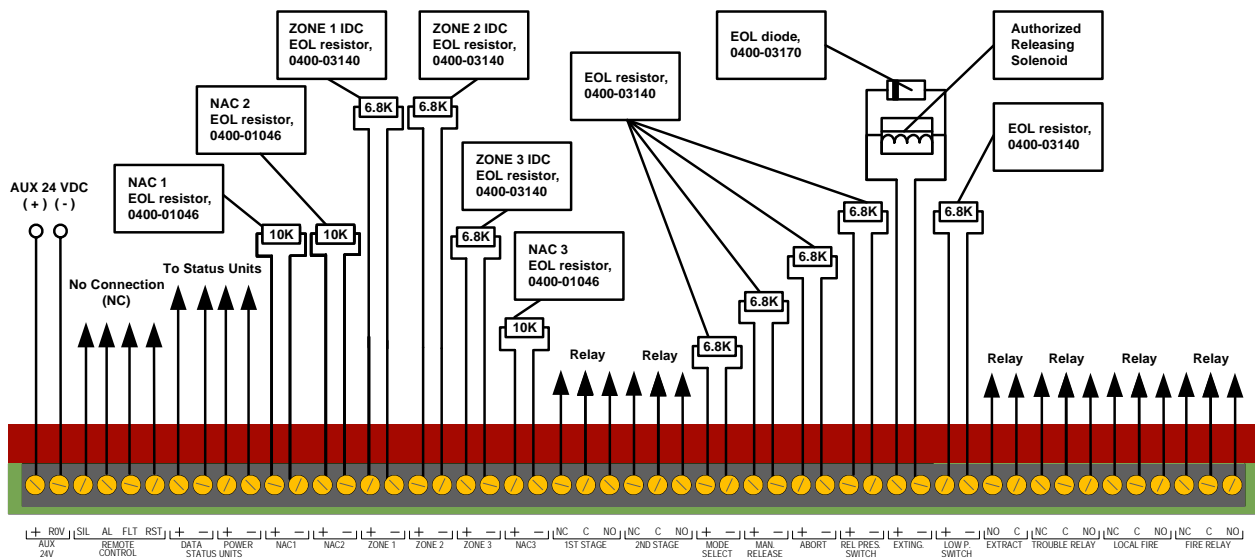

The HCVR-3 Releasing Fire Control Panel provides functions for:

<b>Zone Testing</b>	The zone testing function provides an automatic reset of zones in alarm.
<b>NAC Delay</b>	The NAC delay function suspends the NAC output and permits alarms to be verified before premises are evacuated.
<b>NAC Reactivation</b>	The NAC reactivation function provides an alarm resound.
<b>Voltage Free Relay Contacts</b>	Voltage free relay contacts are provided for local control and signalling.
<b>Releasing Delay</b>	The releasing delay function suspends the releasing signal for up to 60 seconds.
<b>Releasing Signal</b>	The releasing signal provides identification of the pending extinguishant release and the flow of extinguishant during the releasing process.
<b>Low Pressure</b>	The low pressure function provides releasing agent monitoring using a pressure switch to measure low pressure conditions.
<b>Abort</b>	The abort function provides suspension of the releasing count-down when contacts on an external-momentary-switch are closed.
<b>Deactivation Time</b>	The deactivation time function provides a delay setting to control the output quantity of the releasing agent.
<b>Manual Only Mode</b>	The manual only mode disables the releasing operation using automatic detection devices.
<b>First and Second Stage Relays</b>	First and second stage relay contacts are provided to trigger equipment outside the system.
<b>Pre-discharge and Release Warnings</b>	Pre-discharge and release warnings are provided with separate audible tones and frequencies. These operating characteristics allow the two warnings to be differentiated on the fire control panel.
<b>Supervisory Signal Function</b>	The supervisory signal function provides audible and visual indications on the fire control panel and on external status units. This mode also operates the output of the TROUBLE RELAY. All supervisory conditions are non-latching.
<b>Power Source Failure Function</b>	The power source failure function provides immediate audible and visual indications at the fire control panel. The audible and visual indications are also provided on external status units. Status Units can operate the output of the TROUBLE RELAY.
<b>Interconnected status units</b>	Interconnected status units are provided with a limited set of indicators and functions compared with those provided on the HCVR-3 Releasing Fire Control Panel. Status unit functions are non-configurable on the fire control panel.



## Hardware Features

The figure below illustrates hardware features of the HCVR-3 Releasing Fire Control Panel:

**Figure 2-2**  
Hardware Features

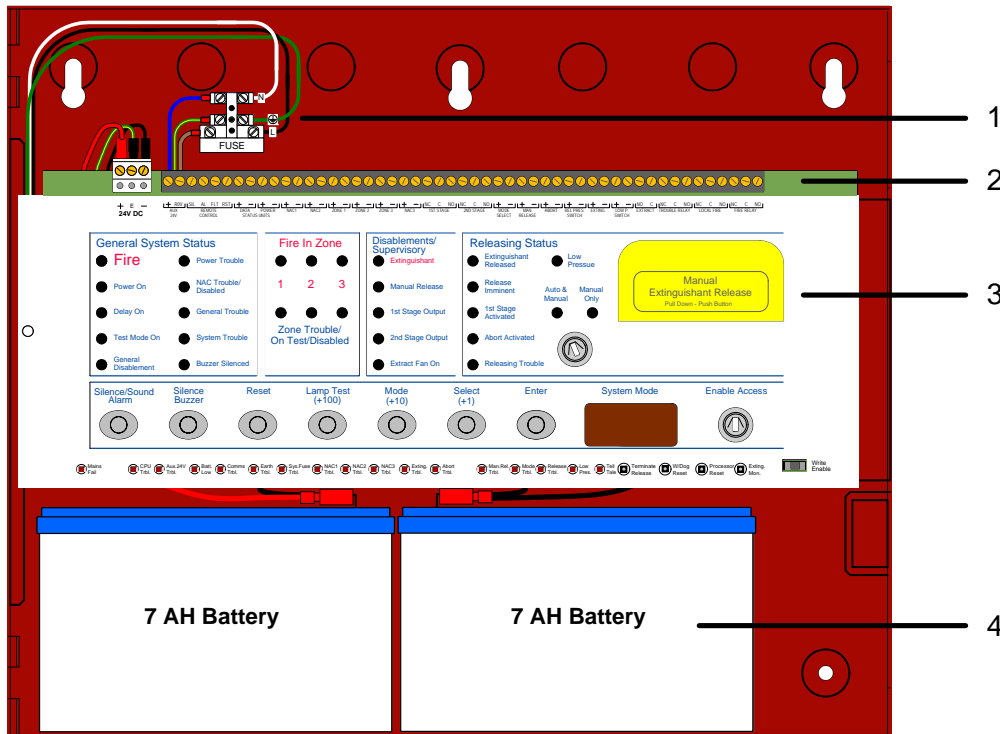

Key	Item	Description
1	Mains Terminal Block	The Mains Terminal Block contains a 1.6 Amp fuse and accepts connections from the transformer primary and input power connections. Connections from the primary of the transformer to the Mains Terminal Block are pre-wired at the factory. Terminals of the Main Terminal Block are designated Line, Neutral and Ground.
2	Field Terminals	Field terminals provide connections for Zones, NACs, Releasing Devices, Relay Outputs, Status Units and AUX 24V.
3	Fascia	The front fascia of the HCVR-3 Releasing Fire Control Panel is populated with controls and indicators for programming and operating the fire control panel.
4	Standby-Batteries	The HCVR-3 Releasing Fire Control Panel contains two 12 VDC, 7 AH batteries for operating the fire control panel during primary AC power failure.

## Internal Power Supply

The internal power supply of the HCVR-3 Releasing Fire Control Panel meets UL 864, 9th edition and provides a 2 Amp, linear power-source for operating FACP functions as well as charging the standby batteries. The 2 Amp power supply operates 115 VAC and 230 VAC models of the HCVR-3 Releasing Fire Control Panel.

*Reference Appendix C, Calculations to determine load current limitations of the 2 Amp power supply*

Features of the internal power supply include:

<b>Battery-backup</b>	Provides battery power to the load when the AC input of the power supply falls below the rated level. The voltage at the load remains within the specified range during these switching-transitions.
<b>Battery-boost</b>	Boosts voltage when the battery voltage drops due to a low-battery condition.
<b>Short-circuit protection</b>	Provides a shut down on the load side of the power supply when the load-current exceeds the maximum level.
<b>Automatic-retry</b>	Restores output to the load when operating conditions return to nominal levels. This feature restores voltage levels at the load following conditions such as over-current and battery depletion.
<b>Status</b>	The AC input to the power supply is supervised by the HCVR-3 Releasing Fire Control Panel with Releasing. The control panel provides an LED status display for normal and trouble conditions. Normal conditions occur when the power supply is operating in an acceptable range. Trouble conditions occur when the power supply is not operating in an acceptable range.

## Power Outputs

The HCVR-3 Releasing Fire Control Panel provides power outputs the terminals of NAC 1, NAC 2, and NAC 3, AUX 24V, STATUS UNITS and EXTING. terminals.

*Reference Section 3, Installation and Appendix A, Specifications for further information concerning NAC, Releasing, Status Unit and AUX 24V outputs of the HCVR-3 Releasing Fire Control Panel.*

## Releasing Circuit

The HCVR-3 Releasing Fire Control Panel provides features for operating releasing signal delay, device supervision, releasing emergency abort, flood control and manual release. The HCVR-3 Releasing Fire Control Panel operates releasing devices in compliance with Fire Protection Service Valves under UL 260, UL 429 and UL 429A.

## NAC Outputs

NAC outputs of the HCVR-3 Releasing Fire Control Panel are programmable and can be operated in regulated or special application mode.

*Reference Appendix A, Specifications for constraints and operating levels of these NAC output modes.*

## Panel Controls and Indicators

The fascia of the HCVR-3 Releasing Fire Control Panel is divided into sections for controls and indicators. The figure below illustrates controls and indicators of the HCVR-3 Releasing Fire Control Panel:

**Figure 2-3**  
Controls and Indicators

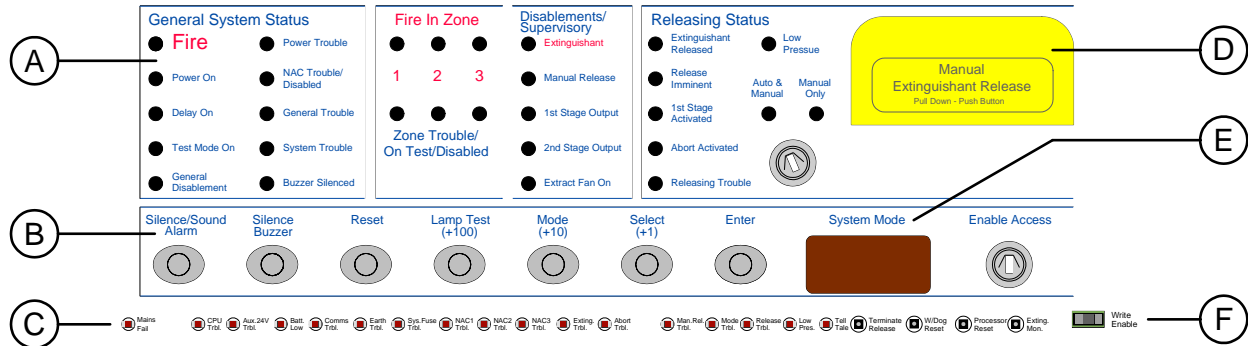

Key	Description	Key	Description
A	Upper Indicators	D	Upper Controls
B	Central Controls	E	Central Indicator
C	Lower Indicators	F	Lower Controls

### Controls

The fascia of the HCVR-3 Releasing Fire Control Panel provides upper, central and lower controls.

#### Upper Controls

The figure below illustrates upper controls of the HCVR-3 Releasing Fire Control Panel:

**Figure 2-4**  
Upper Controls

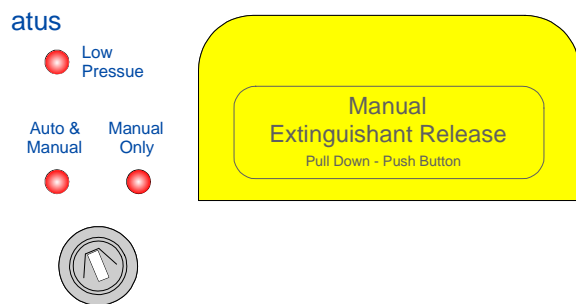

**Hochiki America Corporation**  
**HCVR-3 Series - Conventional Fire Alarm Releasing System**  
**Installation and Operation Manual, HA-06-294, Version V02.10**

The table below describes upper controls of the HCVR-3 Releasing Fire Control Panel:

Controls	Modes
<b>Releasing Key-Switch</b>	Provides key-switch modes for automatic & manual or manual-only release
<b>Manual Extinguishant Release</b>	Provides manual release as a push button

**Central Controls**

The figure below illustrates central controls of the HCVR-3 Releasing Fire Control Panel:

**Figure 2-5  
Central Controls**

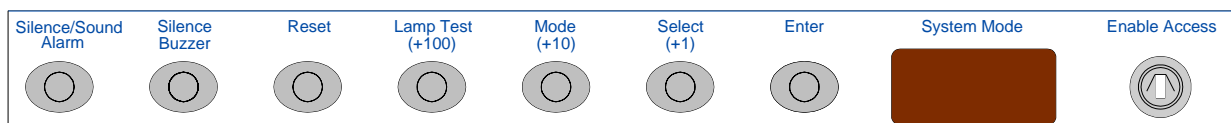

The table below describes central controls of the HCVR-3 Releasing Fire Control Panel:

Controls	Modes
<b>Silence/Sound Alarm</b>	Re-sounds the alarm when NACs are silenced using the Silence Buzzer button.
<b>Silence Buzzer</b>	Silences NACs connected to the HCVR-3 Releasing Fire Control Panel after receiving authorization through Access Level 2.
<b>Reset</b>	Resets latching inputs such as fire and pre-alarm events after receiving authorization through Access Level 2. Trouble events are non-latching inputs and cannot be cleared by the Reset button. Non-latching inputs are cleared when faults are cleared.
<b>Lamp Test</b>	Tests front-panel indicators and the internal buzzer by illuminating all LEDs while darkening the front-panel display and sounding the buzzer.
<b>Mode</b>	Places the menu in a mode for operating or programming the HCVR-3 Releasing Fire Control Panel.
<b>Select</b>	Selects the menu option displayed on the System Mode LED of the front-panel.
<b>Enter</b>	Enables the menu selection to function on the HCVR-3 Releasing Fire Control Panel.
<b>Enable Access</b>	Places the menu of the HCVR-3 Releasing Fire Control Panel in ACCESS LEVEL 2. Insert the key in the Enable Access lock and turn the key to the right to open ACCESS LEVEL 2.

### Lower Controls

The figure below illustrates the lower controls of the HCVR-3 Releasing Fire Control Panel:

**Figure 2-6**  
**Lower Controls**

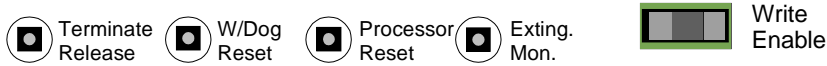

The table below describes lower controls of the HCVR-3 Releasing Fire Control Panel:

Lower Controls	Modes
<b>Terminate Release</b>	Terminates the flow of extinguishant caused by a releasing event and resets the operation of the fire control panel.
<b>W / Dog Reset</b>	Clears the watchdog event caused when the fire control panel failed to carry out an operation.
<b>Processor Reset</b>	Resets processors and restores operation of the fire control panel. This function is also used to re-initialize the processors following a firmware upgrade.
<b>Exting. Mon.</b>	Potentiometer for calibrating the releasing circuit of the fire control panel.
<b>Write Enable</b>	Slide-switch used in conjunction with the Enable Access switch to configure the fire control panel in Access Level 3.

### Indicators

The front-panel of the HCVR-3 Releasing Fire Control Panel provides upper, central and lower indicators.

#### Upper Indicators

The figure below illustrates upper indicators of the HCVR-3 Releasing Fire Control Panel:

**Figure 2-7**  
**Upper Indicators**

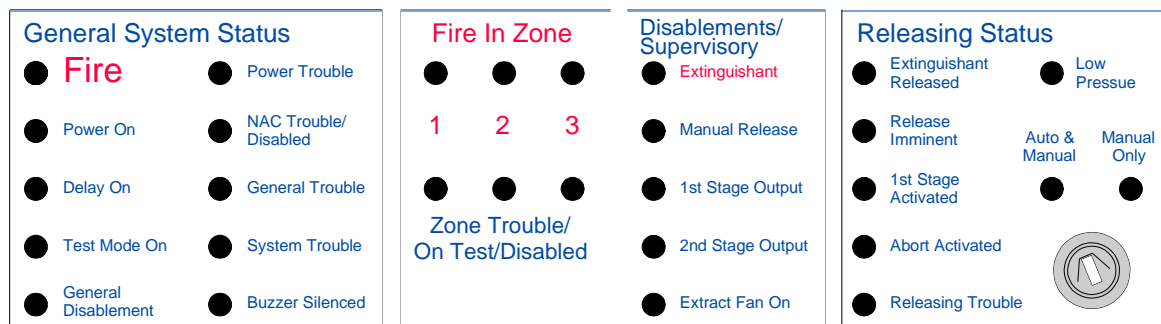

The table below describes upper LED indicators of the HCVR-3 Releasing Fire Control Panel:

General System Status	LED Color
<b>Fire, NAC Output State</b> Flashing = NACs Activated ON Continuous = NACs silenced OFF = Panel and NACs Reset	Red
Power On	Green
Delay On	Yellow
Test Mode On	Yellow
General Disablement	Yellow
Power Trouble	Yellow
NAC Trouble / Disabled	Yellow
General Trouble	Yellow
System Trouble	Yellow
Buzzer Silenced	Yellow
Fire In Zone	LED Color
1	Red
2	Red
3	Red
1 - Zone Trouble / Test / Disablement	Yellow
2 - Zone Trouble / Test / Disablement	Yellow
3 - Zone Trouble / Test / Disablement	Yellow

Disablements / Supervisory	LED Color
Extinguishant	Yellow
Manual Release	Yellow
1st Stage Output	Yellow
2nd Stage Output	Yellow
Extract Fan On	Yellow
Releasing Status	LED Color
Extinguishant Released	Red
Release Imminent	Red
1st Stage Activated	Red
Abort Activated	Yellow
Releasing Trouble	Yellow
Low Pressure	Yellow

**Central Indicators**

The figure below illustrates the central indicator of the HCVR-3 Releasing Fire Control Panel:

**Figure 2-8  
Central Indicators**

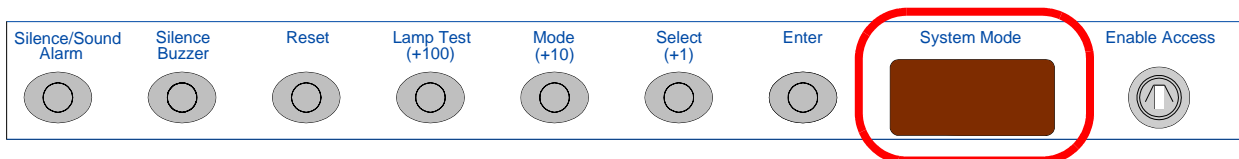

The central indicator is the System Mode display of the HCVR-3 Releasing Fire Control Panel. The System Mode display contains three seven segment LEDs. Use this indicator to identify status conditions and to program configurations on the fire control panel.

### Lower Indicators

The figure below illustrates the lower indicators of the HCVR-3 Releasing Fire Control Panel:

**Figure 2-9**  
**Lower Indicators**



The table below describes lower LED indicators of the HCVR-3 Releasing Fire Control Panel:

Lower LED Indicators	LED Color
Main Fail	Yellow
CPU Trbl.	Yellow
Aux. 24V Trbl.	Yellow
Batt. Fail	Yellow
Comms Trbl.	Yellow
Earth Trbl.	Yellow
Sys. Fuse Trbl.	Yellow
NAC 1 Trbl.	Yellow
NAC 2 Trbl.	Yellow
NAC 3 Trbl.	Yellow
Exting. Trbl.	Yellow
Abort Trbl.	Yellow
Man. Rel. Trbl.	Yellow
Mode Trbl.	Yellow
Release Trbl.	Yellow
Low Pres.	Yellow
Tell Tale	Yellow



## Field Terminals

The figure below illustrates field terminals of the HCVR-3 Releasing Fire Control Panel:

**Figure 2-10**  
**Field Terminals**

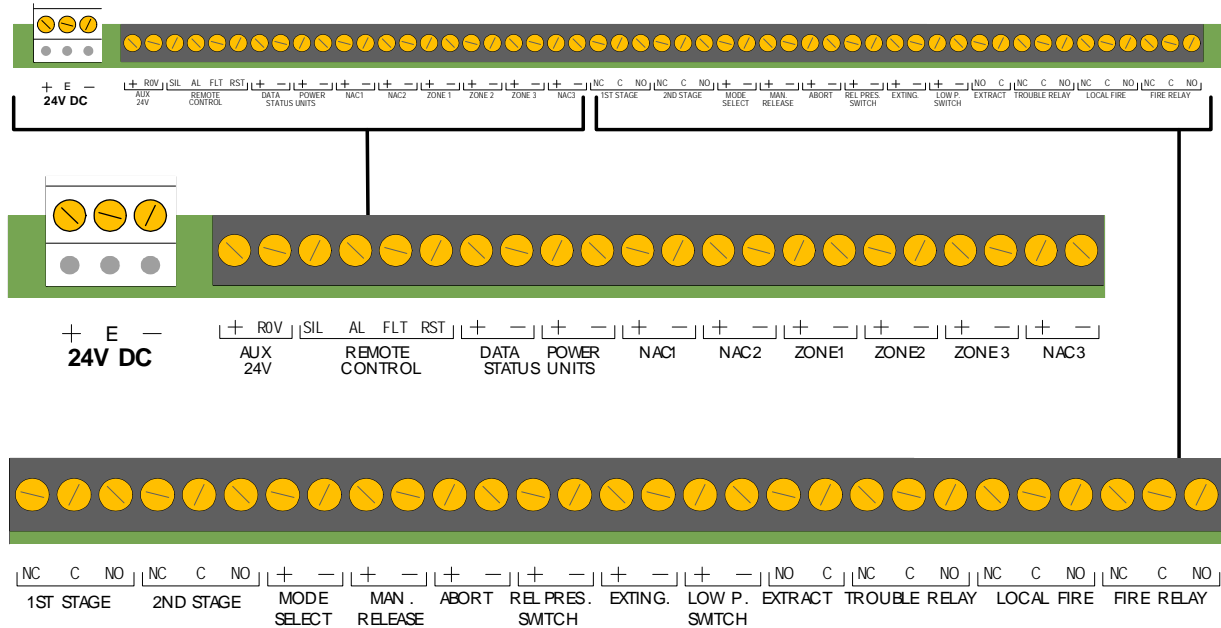

The table below describes field terminals of the HCVR-3 Releasing Fire Control Panel:

Terminal	Description
24V DC	Bridge-rectified 24 VDC from internal transformer
AUX 24V	Auxiliary 18 to 28 VDC terminals
REMOTE CONTROL	Unused function - no connection terminals
DATA - STATUS UNITS	RS485 serial data terminals for Status Units.
POWER - STATUS UNITS	18 to 28 VDC terminals for Status Units.
NAC1, NAC2	18 to 28 VDC terminals for authorized Notification Appliances
ZONE1, ZONE2, ZONE3	Terminals accept only authorized conventional detectors that are two-wire smoke and closed contact-type.

<b>Terminal</b>	<b>Description</b>
<b>NAC3</b>	18 to 28 VDC terminals dedicated to releasing function only. Terminals operate only authorized Notification Appliances
<b>1ST STAGE</b>	Relay contact is 1 Amp maximum with voltage free change-over
<b>2ND STAGE</b>	Relay contact is 1 Amp maximum with voltage free change-over
<b>MODE SELECT</b>	Supervised releasing input with 6.8K Ohm EOL
<b>MAN. RELEASE</b>	Supervised releasing input with 6.8K Ohm EOL
<b>ABORT</b>	Supervised releasing input with 6.8K Ohm EOL
<b>REL PRES. SWITCH</b>	Supervised releasing input with 6.8K Ohm EOL
<b>EXTING.</b>	Releasing output 18 to 28 VDC with 1.0 Amp maximum load for 5 minutes and voltage reversing DC.
<b>LOW PRES. SWITCH</b>	Supervised releasing input with 6.8K Ohm EOL
<b>EXTRACT</b>	Relay contact with contacts for (NO) and (C) that are 1A Amp maximum with voltage free change-over
<b>TROUBLE RELAY</b>	Relay contact is 1 Amp maximum with voltage free change-over
<b>LOCAL FIRE</b>	Relay contact is 1 Amp maximum with voltage free change-over
<b>FIRE RELAY</b>	Relay contact is 1 Amp maximum with voltage free change-over

## Section 3 Installation

---

This section provides instructions for connecting cables, mounting and testing the HCVR-3 Releasing Fire Control Panel for installation.

*Install this product in accordance with NFPA 72, the National Electrical Code and all local codes.*

### General Installation Checklist

To complete the installation:

- 1 Create a plan for the fire alarm system and provide a checklist for installing the fire control panel.
- 2 Identify the operating constraints of the fire alarm system and then determine the battery capacity of the fire control panel.
- 3 Check the contents of the shipping package containing the HCVR-3 Releasing Fire Control Panel.
- 4 Remove the cabinet-door of the HCVR-3 Releasing Fire Control Panel.
- 5 Remove the fascia from the cabinet-box of the HCVR-3 Releasing Fire Control Panel.
- 6 Remove the standby-batteries from the base of the cabinet-box.
- 7 Mark the location for anchoring the cabinet-box to the premises-wall.
- 8 Mount the cabinet-box of the fire control panel to the premises-wall.
- 9 Feed, secure and connect cabling for AC power and field terminals.
- 10 Replace the standby-batteries in the base of the cabinet-box.
- 11 Reattach the fascia to the cabinet-box of the HCVR-3 Releasing Fire Control Panel.
- 12 Reattach the cabinet-door to the cabinet-box.
- 13 Connect the standby-batteries to the HCVR-3 Releasing Fire Control Panel.
- 14 Apply AC power from the main AC power source.
- 15 Test the HCVR-3 Releasing Fire Control Panel installation.

## Before You Begin

Before you begin the installation, take a few minutes to review the installation information, gather the required items, and complete the tasks listed below to make the installation as quick and easy as possible.

- 1 Create a plan and checklist before beginning the installation process. Planning can reduce the number of problems that can occur during installation.
- 2 Select a mounting site that is a suitable operating environment for the HCVR-3 Releasing Fire Control Panel. The mounting site chosen should be clean, dry and not subject to shock or vibration.
- 3 Remove the HCVR-3 Releasing Fire Control Panel from the shipping package and check the contents to determine if the order has been satisfied.  
*Contact technical support if material is missing from the shipping package.*

### CAUTION!



Electronic components within the HCVR-3 Releasing Fire Control Panel are vulnerable to damage caused by electrostatic discharge. Ground straps must be worn by installers before handling electronic components to prevent this damage.

- 4 Acquire the following items that are not included with the HCVR-3 Releasing Fire Control Panel, but may be required for the installation:

Item	Quantity	Description
<b>Mounting Hardware</b>	1	The mounting hardware that secures the HCVR-3 Releasing Fire Control Panel to the premises-wall is not provided in the packaging.
<b>Ground Strap</b>	1	A ground strap is required for handling electronic components of the HCVR-3 Releasing Fire Control Panel. <i>The ground strap is not provided in packaging of the HCVR-3 Releasing Fire Control Panel.</i>

### CAUTION!



Disconnect power before removing circuit boards of the HCVR-3 Releasing Fire Control Panel. Never insert or remove circuit boards while powering the fire control panel. Electronic components can be permanently damaged when circuit boards of the HCVR-3 Releasing Fire Control Panel are removed while receiving power.

## Determining System Current Draw

Determine the current draw of the fire alarm system for alarm and standby conditions. Use these maximum current values to obtain the operating constraints of the fire alarm system and the battery capacity of the fire control panel.

### Standby-Battery Capacity

Perform the installation only after calculations have been completed for a suitable battery size. Battery standby-hours are dependant on battery capacity and load of the fire alarm system.

*Reference Appendix C, Calculations to determine the standby-battery capacity of the system.*

### Operating Constraints

Operating constraints must be included in the planning of the fire control panel to maintain reliable *standby* and *alarm* operation. Operating constraints are based on the current-loading of the fire control system and the current-driving capability of the fire control panel. Current-loading in a fire control system can be caused by individual or multiple combinations of zone circuits, signaling line circuits, notification appliances, initiating devices and cabling. Select circuit devices and cabling for the fire control system that does not exceed the current driving capability of the HCVR-3 Releasing Fire Control Panel.

*Reference Appendix A, Specifications and Appendix C, Calculations to determine specific operating constraints for devices and cabling connected to the HCVR-3 Releasing Fire Control Panel.*

## Mounting the Fire Control Panel

This section describes preparing, removing the fascia and mounting the HCVR-3 Releasing Fire Control Panel.

### Preparing

Complete the following steps to prepare the fire control panel for mounting:

- 1 Open the cabinet-door of the fire control panel using the door-lock-key.
- 2 Disconnect the green ground cable from the cabinet-door.
- 3 Remove the cabinet-door from the cabinet-box of the HCVR-3 Releasing Fire Control Panel.
- 4 Remove the fascia from the cabinet-box.
- 5 Remove the standby-batteries from the base of the cabinet-box.
- 6 Mark the location for mounting the cabinet-box to the premises-wall.

## Removing the Fascia

Remove the fascia of the HCVR-3 Releasing Fire Control Panel prior to the mounting process to prevent damage to circuit board components.

To remove the fascia from the cabinet-box of the HCVR-3 Releasing Fire Control Panel:

- 1 Remove the two mounting-screws on the fascia that secure it to the cabinet-box.
- 2 Remove the ground connection from the fascia.
- 3 Remove the fascia from the cabinet-box and place it in a safe location while mounting the cabinet-box.

The figure below illustrates the location of the fascia mounting-screws:

**Figure 1-1**  
**Fascia Mounting-Screws**

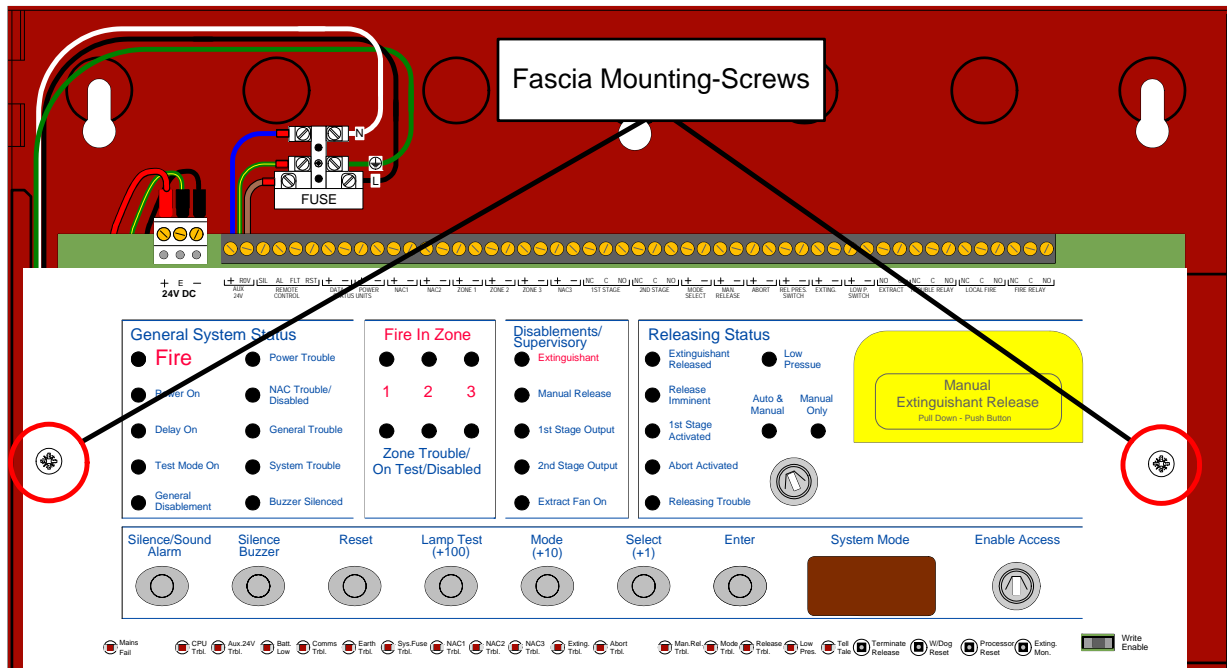

## Mounting

Drill holes in the premises-wall to mount the cabinet-box of the HCVR-3 Releasing Fire Control Panel using mounting-hardware to secure it. Screws or bolts providing a minimum diameter of 0.2" (5 mm) must be used to mount the cabinet-box in three mounting positions. Remove debris from the base of the cabinet-box that accumulates during the mounting process.

The figure below illustrates mounting the cabinet-box of the HCVR-3 Releasing Fire Control Panel:

**Figure 1-2**  
**Mounting the Cabinet-Box**

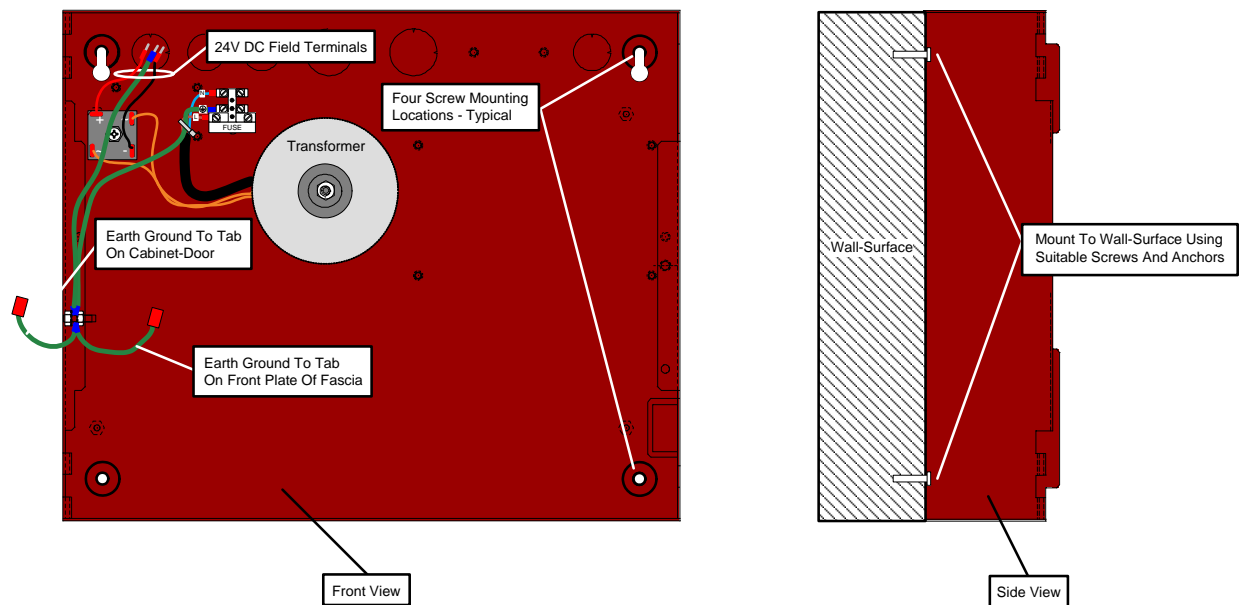

### CAUTION!



Maintain care when anchoring the HCVR-3 Releasing Fire Control Panel to the premises wall. Electronic components within the fire control panel are vulnerable to physical damage from shock and vibration. Remove the fascia of the HCVR-3 Releasing Fire Control Panel when installations cannot guarantee a level of care during the wall-anchoring process.

## Separation of Circuits

Cabling from the main power source is non-power limited and must be separated from all other cabling by a minimum ¼ inch spacing. When the product design requires or permits power limited circuit conductors to occupy the same enclosure as non-power limited conductors, specific wire routing configurations must be detailed to ensure a minimum ¼ inch spacing between non-power and power limited circuit conductors.

All circuits of the HCVR-3 Releasing Fire Control Panel are power limited except AC input, AC output, battery, transformer input, transformer output, bridge rectifier input and bridge rectifier output.

*Reference UL 864 12.3.1.*

**Hochiki America Corporation**  
**HCVR-3 Series - Conventional Fire Alarm Releasing System**  
**Installation and Operation Manual, HA-06-294, Version V02.10**

The figure below illustrates separation of non-power limited and power limited circuit-cabling.

**Figure 1-3**  
**Separation of Non-Power Limited and Power Limited Circuit-Cabling**

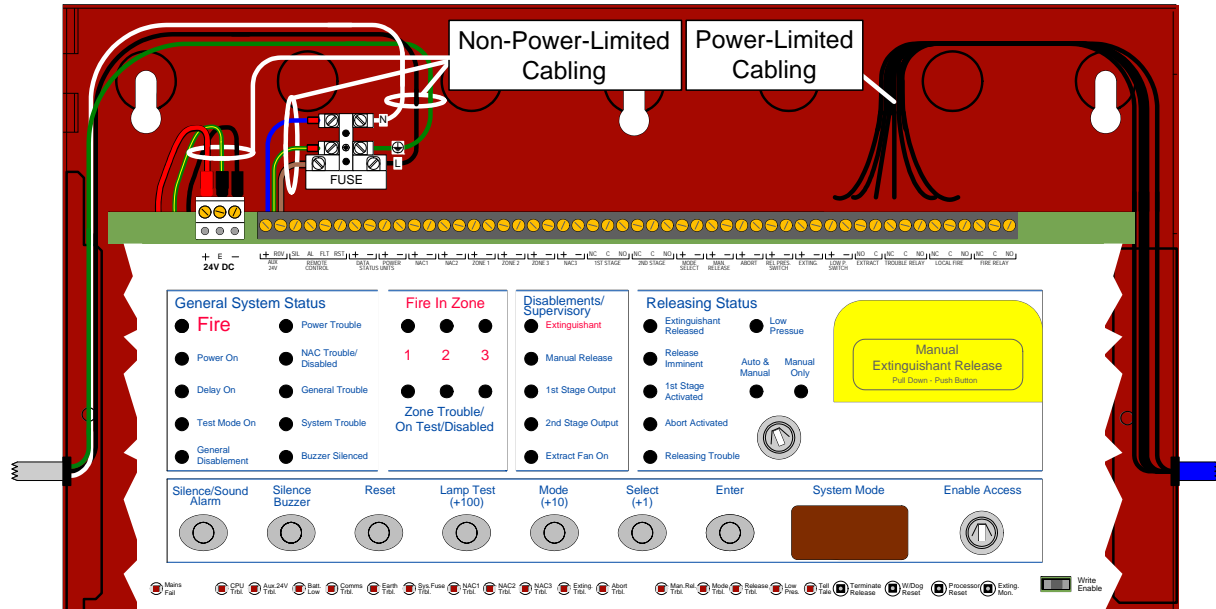

## AC Cabling

Power cabling from the mains to the HCVR-3 Releasing Fire Control Panel must provide connections to branch circuits containing a 15 Amp fuse. Specify 14 AWG wiring for this connection. Power cabling must enter the at the back, top or left-side of the fire control panel cabinet through the cabinet-knockouts.

Feed AC cabling in the cabinet of the HCVR-3 Releasing Fire Control Panel.

To feed cabling into the cabinet:

- 1 Remove knockout tabs from the right and left-side of the cabinet.
- 2 Feed AC cabling in the left-side knockout-tab-hole.
- 3 Feed all other cabling in the right-side knockout-tab-hole. Remove additional knockout-holes on the right-side of the cabinet to provide more cabling as required.

The fire control panel requires an input of 115 VAC @ 50 / 60Hz or an input of 230 VAC @ 50 / 60Hz. The fused terminal block contains a 1.6 A fuse rated at 250 VAC.

Connect AC cabling from the power source to the main terminal block. The main terminal block is located on the top-left of the HCVR-3 Releasing Fire Control Panel. Mains wiring must include a secure earth ground connection from the building ground to the fire control panel and must enter the fire control panel cabinet as close as possible to the mains terminal block. Limit the length of mains wiring from the cabinet opening to the mains terminal block of the fire control panel and dress mains wiring with cable ties.

**Hochiki America Corporation**  
**HCVR-3 Series - Conventional Fire Alarm Releasing System**  
**Installation and Operation Manual, HA-06-294, Version V02.10**



The figure below illustrates supervised connections at the mains terminal block for the Line (L), Neutral (N) and Ground of the AC power source.

**Figure 1-4**  
**Supervised Connections At The Mains Terminal Block**

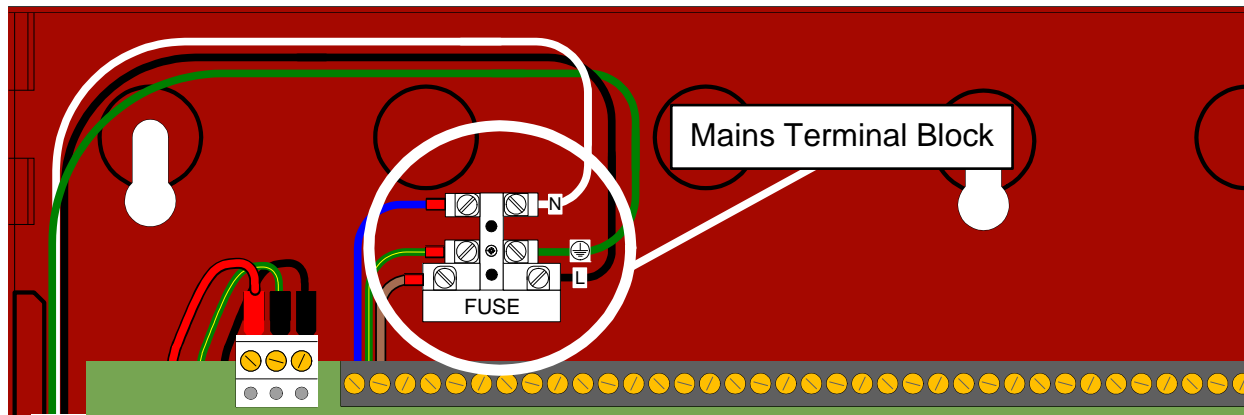

Reference Appendix A, Specifications for the wire-gage requirements of these connections.

## Standby-Battery Cabling

Perform the installation only after calculations have been completed for selecting a suitable battery size. Battery standby-hours are dependant on battery capacity and loading of the FACP system.

To install the replacement standby-batteries:

- 1 Place standby-batteries at the bottom of the HCVR-3 Releasing Fire Control Panel cabinet.
- 2 Connect the black battery-lead to the negative terminal of Battery 2.
- 3 Connect the red battery-lead to the positive terminal of Battery 1.
- 4 Connect the jumper-lead from the negative terminal of Battery 1 to the positive terminal of Battery 2.
- 5 Mark a "placed into service" date" on Battery 1 and Battery 2.

*Do not connect the two batteries in parallel. A parallel connection will not provide the 24 volts required for operating the HCVR-3 Releasing Fire Control Panel in a standby condition.*

The recharging circuit of the power supply charges batteries to a maximum voltage of 27.6 VDC @ 700 mA. The fire control panel accepts sealed-lead-acid rechargeable-batteries with a maximum capacity of 7 AH. The maximum current drawn from the batteries is 2 Amps when the main power source is disconnected.

Observe polarity when connecting the leads of the standby-batteries to the fire control panel. Improper connections to the standby-batteries could damage the fire control panel and severely limit overall fire control panel operation. Connect two standby-batteries to the power supply in series.

**Hochiki America Corporation**  
**HCVR-3 Series - Conventional Fire Alarm Releasing System**  
**Installation and Operation Manual, HA-06-294, Version V02.10**

Reference Section 5, Maintenance for replacing the standby-batteries.

The figure below illustrates standby-battery connections in the HCVR-3 Releasing Fire Control Panel:

**Figure 1-5  
Standby-Battery Connections**

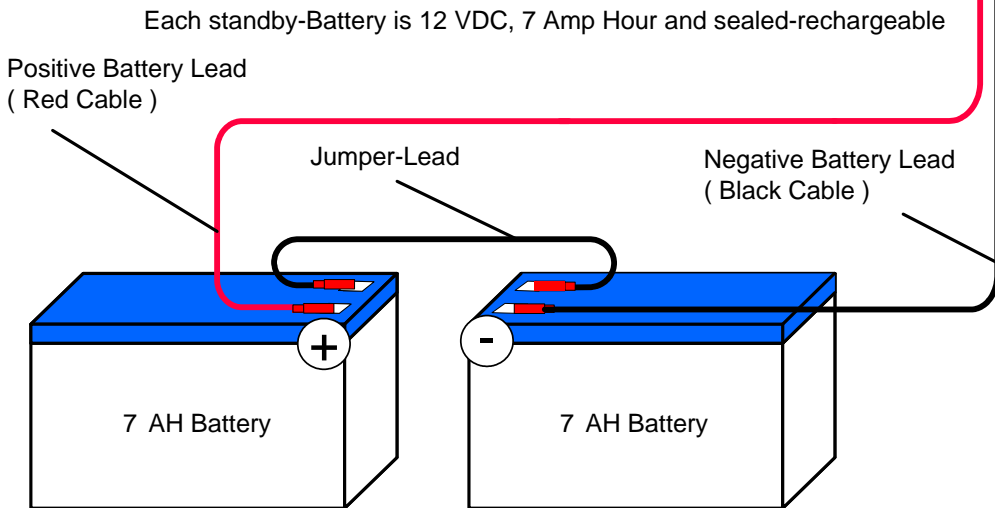
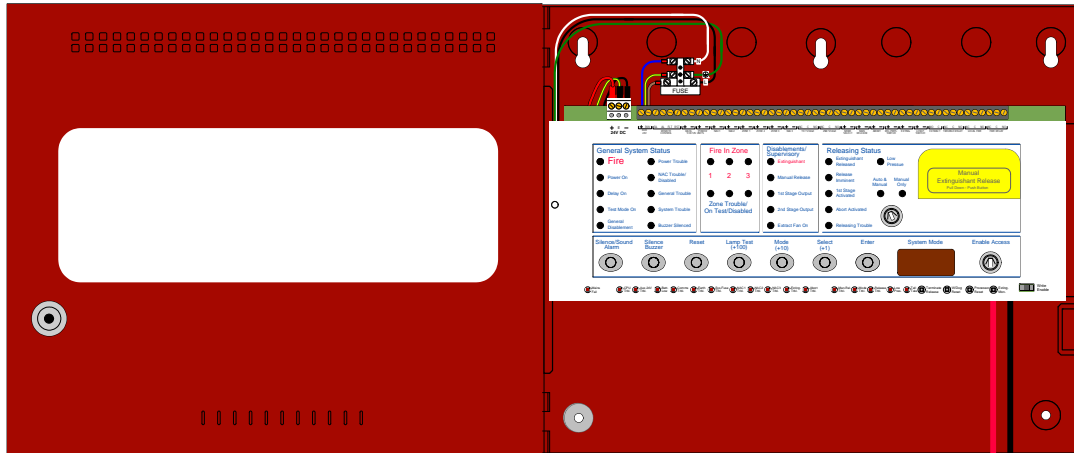

The illustrated series connection above provides a standby voltage of 24 VDC required by the HCVR-3 Releasing Fire Control Panel.

## Field Cabling

Field cabling of the HCVR-3 Releasing Fire Control Panel includes terminal connections for detection zones, supervised inputs, Notification Appliance Circuits (NACs), releasing device circuits, relay outputs, AUX 24V power and Status Units. Connect all field wiring to the single row of terminals along the top of the fire control panel. Terminals accept wiring from 14 to 18 AWG. Wiring outside of the fire control panel must not be routed across the front surface of the fire control panel.

## Detection Zones

This section describes connections for detection zones of the HCVR-3 Releasing Fire Control Panel. Detection zones are Initiating Device Circuits (IDC). Initiating Device Circuits of the HCVR-3 Releasing Fire Control Panel are power limited and include:

<b>Detection Zones</b>	Include connections for ZONE 1, ZONE 2 and ZONE 3
<b>Supervised Inputs</b>	Include connections for MAN RELEASE, ABORT, REL. PRES. SWITCH and the LOW P. SWITCH
<b>Remote Control Inputs</b>	Remote Control connections ROV, SIL, AL, FLT, RST are unused on the HCVR-3 Releasing Fire Control Panel and are designated as No Connect (NC) terminals.
<b>Mode Select</b>	Mode Select connections are unused on the HCVR-3 Releasing Fire Control Panel and are designated as No Connect (NC) terminals.

Detection zones of the HCVR-3 Releasing Fire Control Panel provide a nominal 24 VDC for powering conventional detectors and pull stations. Detectors must be wired in a daisy-chain without T-Top connections. Detection zones are supervised for open-circuit, short-circuit and ground-fault conditions with the installation of the 6.8K Ohm EOL resistor, 0400-03140. Place the 6.8K Ohm EOL resistor across the last device in the detection zone circuit to provide this supervision.

*Pull-stations authorized for use with the HCVR-3 Releasing Fire Control Panel are non-addressable and UL listed.*

Zones of the HCVR-3 Releasing Fire Control Panel operate NFPA 72 Class B, Style C or NFPA 72, Class B, Style B. Style C devices provide trouble conditions for direct shorts and opens on zone loops. Style B devices provide alarm conditions for direct shorts and trouble conditions for opens on zone loops.

Change the default operation of Style C to Style B by using the appropriate configuration code. Set the following configuration code on the fire control panel to provide a Class B alarm when a short circuit condition occurs in Zone 1, 2 or 3:

- Set C71 to alarm when a short circuit condition occurs in Zone 1.
- Set C72 to alarm when a short circuit condition occurs in Zone 2.
- Set C73 to alarm when a short circuit condition occurs in Zone 3.

*The maximum number of detectors per zone is device and manufacturer dependent.*

The figure below illustrates a single detector connection on the zone terminals of the HCVR-3 Releasing Fire Control Panel:

**Figure 1-6  
Single Detector Connection**

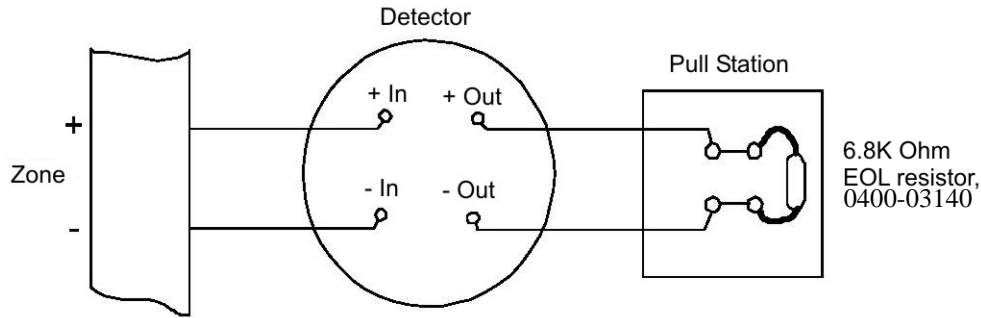

**Supervised Inputs**

Supervised inputs of the HCVR-3 Releasing Fire Control Panel are Class B, Style C Initiating Device Circuits (IDC). Supervised inputs include the field terminals of MAN RELEASE, ABORT, REL. PRES. SWITCH and LOW P. SWITCH. These inputs are supervised for open-circuit, short-circuit and ground-fault conditions.

Circuits operating on these terminals require a 6.8K Ohm EOL resistor, 0400-03140 and a nominal, 470 Ohm trigger resistor, 0400-03150.

The figure below illustrates a typical supervised input connection on terminals of the HCVR-3 Releasing Fire Control Panel.

**Figure 1-7  
Supervised Inputs**

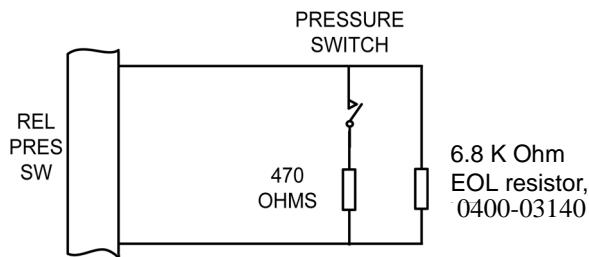

## Remote Control Inputs

Remote Control Inputs are unused on the terminal-strip of the fire control panel:

Terminal	Function
ROV	No Connection (NC)
SIL	NC
AL	NC
FLT	NC
RST	NC

## Notification Appliance Circuit (NAC)

*Notification Appliance Circuit (NAC) outputs of NAC 1, NAC 2 and NAC 3 are rated for special application and regulated outputs. The NAC channels are rated for special application conditions when each output operates at or below 500 mA. A maximum load of 1.5 A is available for powering the NAC outputs when a maximum load of 500 mA is operating on any one of the NAC outputs. The NAC channels are rated for regulated conditions when each output operates at or below 50 mA.*

NAC circuits are supervised for ground-faults, open and short circuit conditions by placing a 10K EOL resistor, 0400-01046 across the last device on the circuit. NAC circuits must be wired as a single circuit to enable the supervising circuit to operate. NAC circuits must also be wired in a daisy-chain without T-Top connections.

*NAC outputs of the HCVR-3 Releasing Fire Control Panel accept devices that are polarized only. A trouble condition is reported when non-polarized NAC devices are connected to these NAC outputs.*

### NAC 1 and 2

*NAC 1 and 2 of the HCVR-3 Releasing Fire Control Panel provide single and dual circuit synchronization for Zones 1 and 2 when operating with authorized synchronization modules. Single circuit synchronization provides synchronized NAC outputs on one channel of the HCVR-3 Releasing Fire Control Panel. Dual circuit synchronization provides synchronized NAC outputs on two channels of the HCVR-3 Releasing Fire Control Panel.*

*The output of NAC 1 and NAC 2 is special application and provides a continuous DC voltage.*

*Reference Appendix A, Specifications to identify characteristics of the NAC 1 and NAC 2 special application outputs. Reference Appendix B, Equipment List for a list of compatible NAC devices.*

### NAC Extenders

Listed NAC Extenders that perform in the range of 18 to 28 VDC and draw less than 500 mA are authorized to operate on the outputs of NAC 1 and NAC 2.

*Reference manufacturer instructions for specific NAC Extender connections and requirements.*

**Example EOL and Trouble Relay Connection**

Provide a series connection from the NAC output to the End of Line (EOL) and the trouble relay of the NAC Extender. During a trouble condition the normally closed (NC) contacts of the trouble relay open on the NAC Extender providing a trouble condition on the HCVR-3 Releasing Fire Control Panel.

The figure below illustrates an example NAC Extender containing an EOL and trouble relay connection:

**Figure 1-8**  
**Example EOL and Trouble Relay Connection**

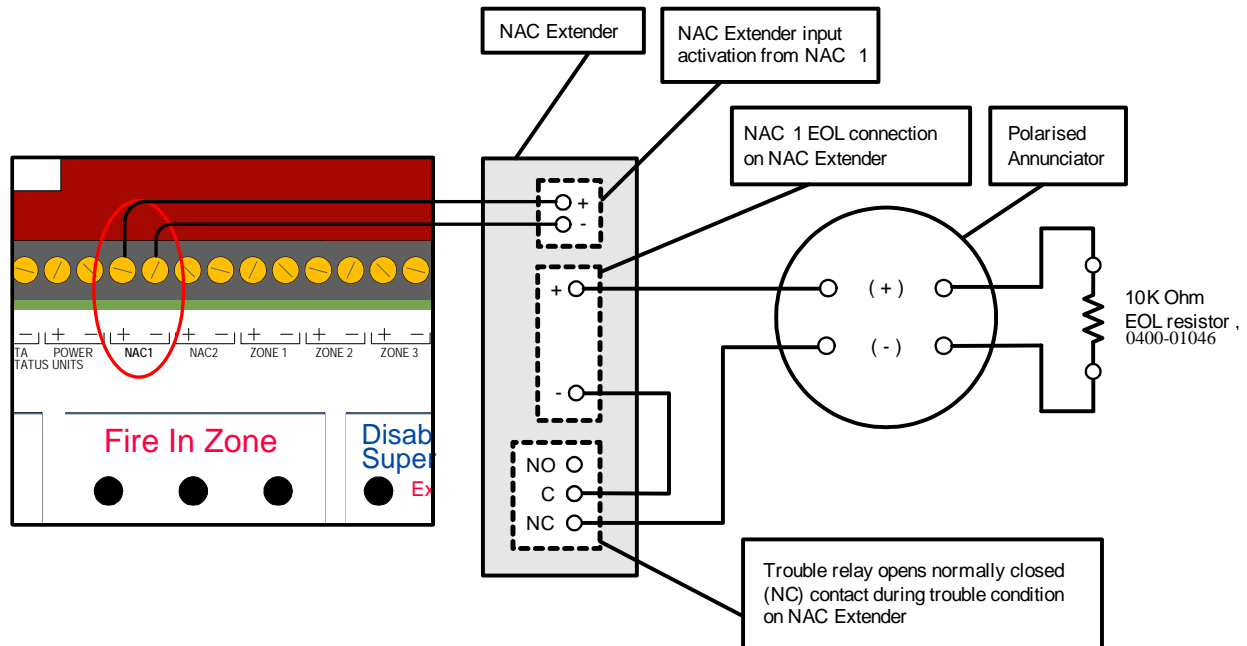

**Example Cooper Industries Connection**

Provide a connection from the NAC output to the NAC Extender PS-8 of Cooper Industries. During a trouble condition inputs open on the 1N1 terminals of the NAC Extender PS-8 providing a trouble condition on the HCVR-3 Releasing Fire Control Panel.

The figure below illustrates an example NAC Extender PS-8 connection:

**Figure 1-9**  
**Example PS-8 NAC Extender Connection**

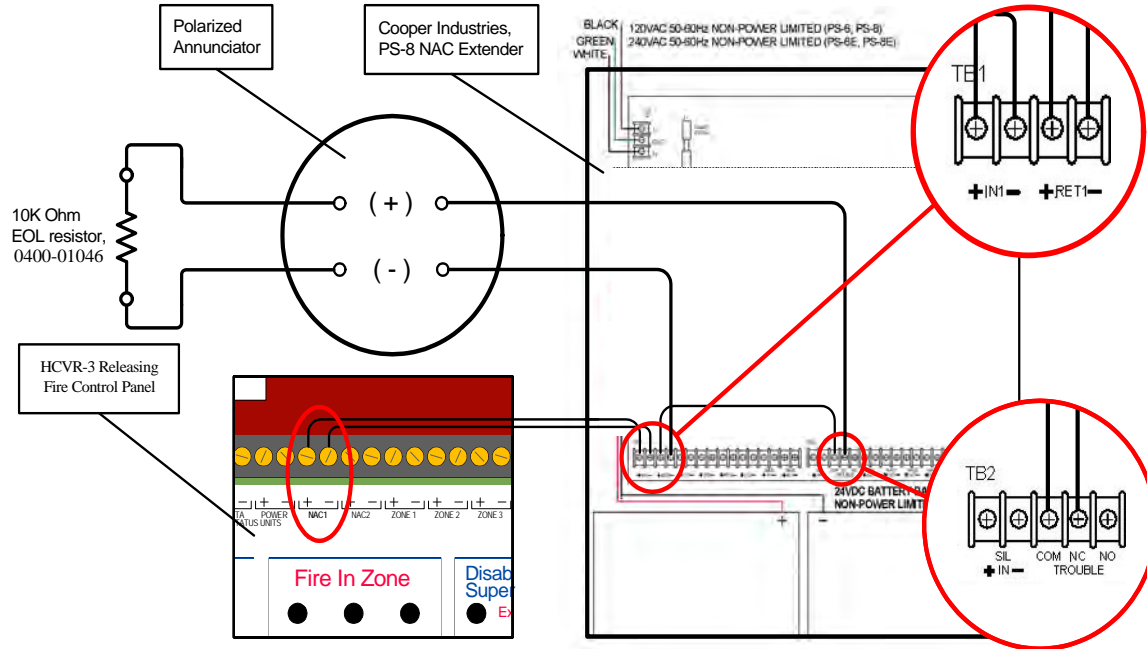

**NAC 3**

NAC 3 is designed to operate the releasing notification appliances of the HCVR-3 Releasing Fire Control Panel only. NAC 3 provides a special application output that is pulsed and continuous. The pulsed output of NAC 3 prevents it from operating strobe devices or synchronizing with devices on NAC 1 and NAC 2.

**CAUTION!**



NAC synchronization operates on NAC 1 and NAC 2 only. Do not connect NAC 3 for synchronization. NAC synchronization cannot be performed between multiple HCVR-3 Releasing Fire Control Panels.

The figure below illustrates NAC1 wiring on the HCVR-3 Releasing Fire Control Panel:

**Figure 1-10**  
**NAC1 Wiring**

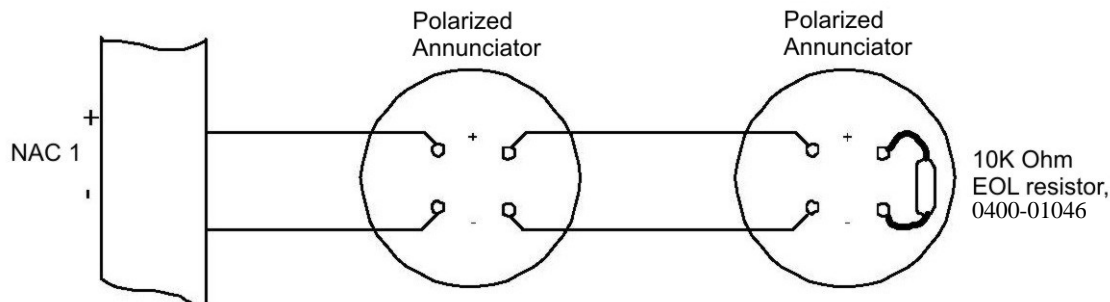

To install Notification Appliance Circuits (NACs) on the HCVR-3 Releasing Fire Control Panel:

- 1 Connect Notification Appliances and End-Of-Line-Devices to the NAC channel.  
*Notification Appliances must be wired in a daisy-chain without T-Top connections. End-Of-Line-Devices must be connected to the last Notification Appliance in the daisy-chain.*
- 2 Maintain the limit for maximum wire length of the circuit.
- 3 Maintain maximum current limits and loading.

## Releasing Circuit

This section describes how to install releasing devices on the EXTING terminals of the HCVR-3 Releasing Fire Control Panel. The HCVR-3 Releasing Fire Control Panel operates releasing devices in compliance with Fire Protection Service Valves under UL 260, UL 429 and UL 429A.

*The HCVR-3 Releasing Fire Control Panel provides releasing operation on the EXTING terminals.*

To maintain UL compliance during installation:

- Connect releasing devices to the EXTING terminals
- Connect releasing devices with the correct wire gage and length
- Connect only authorized releasing devices for Fire Protection Service Valve operation
- Connect EOL diode 1N504-G, 0400-03170 to the releasing solenoid

## Solenoid Wiring

Solenoids must have a resistance of greater than 30 Ohms to ensure that the maximum current rating of the releasing output is not exceeded.

Shunt releasing solenoids with the End of Line Diode (EOLD) 1N504-G, 0400-03170. The EOLD 0400-03170 provides supervision for releasing circuits and prevents solenoid EMF spikes from interfering with the operation of the fire control panel.



Connect the EOLD 1N504-G, 0400-03170 in the same junction box as the Releasing Solenoid.

The HCVR-3 Releasing Fire Control Panel operates only authorized solenoid releasing valves.

*Reference Appendix B, Equipment List for a list of Authorized Releasing Valves.*

The figure below illustrates an example of the wiring for the releasing solenoid:

**Figure 1-11**  
**Releasing Solenoid Wiring**

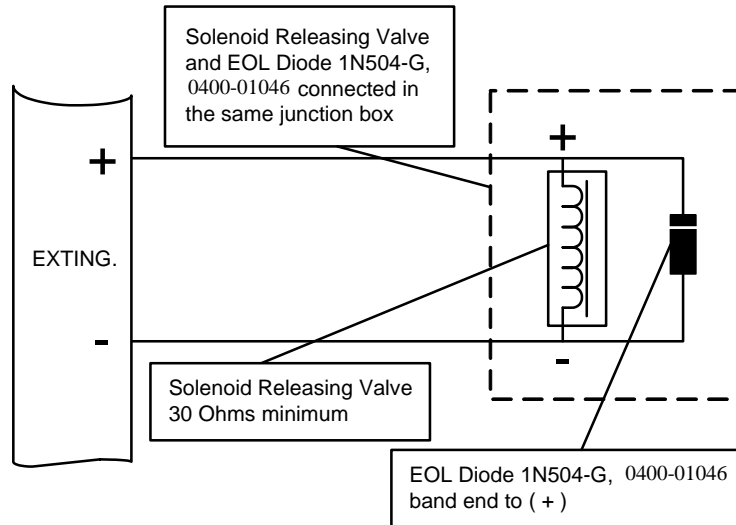

### Monitoring Circuit

All control panels are supplied with end of line diodes for the connection of solenoids. It should not be necessary to adjust the trouble monitoring circuit in this configuration, unless the panel fails to report a short circuit trouble when tested by shorting the end of line device.

#### **Halon 1301**

If the system is intended for Halon 1301 the user must install a mechanical manual release.

#### **Manual Release**

- If abort is activated first, the manual release overrides the abort function.
- If manual release is activated first, the abort function overrides the manual release.

The Manual Release Switch shall be marked “Manual Release” or “Manual Dump” at its installed location. The Manual Release can override an activated Abort condition.

## Relay Outputs

Volt free changeover relay contacts are provided for local control and signalling. These contacts are rated for switching signalling circuits and must be operated within specified ratings.

*Reference Appendix A, Specifications for relay ratings of HCVR-3 Releasing Fire Control Panel.*

Typically, the Aux 24V output of the fire control panel is switched through these relays and used to control other systems.

## Aux 24V

The AUX 24V connection is a common special application output. The output is supervised for short-circuits and ground faults. The output is not supervised for open circuit conditions. Terminals of the Aux 24V supply are labelled (+) and ROV. The ROV terminal is the negative terminal.

## Operating Limits

The AUX 24V supply is protected by an electronic, self resetting fuse rated at 1.1 A. Devices connected to this output must not draw current in excess of 500 mA. Operate expansion-boards, Status Units and Ancillary Boards on this special application output.

## Fire Control Panel - Status Unit Terminals

This section describes the Status Unit terminals of the HCVR-3 Releasing Fire Control Panel. Status Unit terminals of the HCVR-3 Releasing Fire Control Panel contain connections for Data and Power. The Data terminals provide RS485 communication. The Power output of these terminals is designed to operate the Status Unit and the Ancillary Board only.

*The Power output of the Status Units terminals is special application and supervised.*

*A common earth ground is required between all Status Units and each fire control panel.*

The figure below illustrates the STATUS UNIT terminals of the HCVR-3 Releasing Fire Control Panel:

**Figure 1-12**  
**STATUS UNIT Terminals**

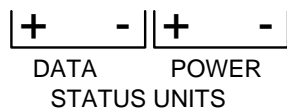

## Testing the Installation

Disconnect the releasing solenoid from the fire control panel circuit before applying power. This step physically isolates the releasing solenoid from the fire control panel and prevents accidental discharge of the releasing agent.

To test the installation of the HCVR-3 releasing Fire Control Panel:

- 1 Disconnect wiring from the EXTING. terminals to the releasing solenoid before applying power from the source.

*Do not disconnect the EOL diode from the releasing solenoid.*

- 2 Apply power to the fire control panel from the source.
- 3 Confirm that the Power On lamp on the fascia is illuminated.
- 4 Confirm that the fire control panel is not reporting trouble conditions.

Correct conflicts before proceeding with the testing if trouble conditions are reported by the fire control panel. Once the fire control panel is trouble free, it can be configured and tested to ensure that it operates as configured.

- 5 Reconnect the releasing solenoid to the EXTING. terminals of the fire control panel after the completion of successful testing.

## Troubleshooting

Troubleshoot the HCVR-3 Releasing Fire Control Panel when conflicts exist after installing or configuring. Monitor the lower fascia indicators of the fire control panel to determine the cause of the trouble condition. The lower indicators of the fascia are visible after opening the cabinet-door of the HCVR-3 Releasing Fire Control Panel.

The figure below illustrates lower fascia indicators of the HCVR-3 Releasing Fire Control Panel:

**Figure 1-13**  
**Troubleshooting with Lower Fascia Indicators**



Indicator	Description
<b>Mains Fail</b>	The 230V AC supply is not present and the system is running on standby batteries. If there is not a power cut, check the fuse of the main terminal block if there has not been a loss of source power.
<b>Batt Fail</b>	The standby battery has become disconnected or that the charging circuit of the fire control panel has failed. Check that both batteries are connected and linked together. Test battery. Disconnect battery and ensure that 28 Volts can be measured on battery charger leads.
<b>CPU Trbl</b>	The central processor unit has failed to execute code and has been re-started by the system watchdog. The watchdog reset switch must be pressed to clear the CPU trouble condition. Press watchdog reset. If system does not return to normal then the panel is probably damaged and needs the circuit board replaced.
<b>Aux 24V Trbl</b>	The Aux 24V and R0V terminals provide a 500 milliamp, 24V DC power supply for power fire alarm ancillary equipment. This LED indicates that fuse protecting the R0V output has operated and the rating of this output has been exceeded. The fuse is a self resetting type and the supply will resume when the trouble condition is removed.
<b>Batt Low</b>	Illuminates when the system is running on batteries and the battery voltage is between 21.5 V and 20.5 V (the minimum battery voltage).
<b>Comms Trbl</b>	Communication has been lost with a remote annunciator or Ancillary board. Check for comms trouble at all remote annunciators and ancillary boards to identify the source of the problem. The comms trouble LED will be accompanied by the front panel Flooding zone trouble LED to indicate a common trouble condition within the releasing agent section of the fire control panel.
<b>Earth Trbl</b>	Part of the system wiring is connected to earth. Remove all system wiring and re-connect cables one at a time until the earth trouble returns. This will indicate which cable the earth trouble is present on.

Indicator	Description
<b>Sys Fuse Trbl</b>	The power rating of the power supply has been exceeded and the system fuse has operated. Remove and review all loads and re-connect one at a time until over rated circuit trips fuse to identify faulty circuit.
<b>S1, S2 and S3 Trbl</b>	A short or open circuit exists on NAC outputs. Remove wiring and reconnect EOL resistors. Check NAC circuit wiring. The S3 LED will be accompanied by the front panel Flooding zone trouble LED to indicate a common trouble condition within the releasing agent section of the fire control panel.
<b>Exting Trbl</b>	A short or open circuit exists on the releasing agent output. Remove wiring and reconnect EOL resistors. Check releasing agent circuit wiring. The Exting trouble LED will be accompanied by the front panel Flooding zone trouble LED to indicate a common trouble condition within the releasing agent section of the fire control panel.
<b>Abort Trbl</b>	A short or open circuit exists on the abort switch input. Remove wiring and reconnect the EOL. Check abort circuit wiring. The Abort Trbl LED will be accompanied by the front panel Flooding zone trouble LED to indicate a common trouble condition within the releasing agent section of the fire control panel.
<b>Manual Release Trbl</b>	A short or open circuit on the manual release switch input. Remove wiring and reconnect EOL. Check manual release circuit wiring. The Manual release trouble LED will be accompanied by the front panel Flooding zone trouble LED to indicate a common trouble condition within the releasing agent section of the fire control panel.
<b>Mode Trbl</b>	A short or open circuit exists on the mode switch input. Remove wiring and reconnect the EOL. Check mode circuit wiring. The Mode Trbl LED will be accompanied by the front panel Flooding zone trouble LED to indicate a common trouble condition within the releasing agent section of the fire control panel.
<b>Release Trbl</b>	A short or open circuit exists on the released pressure switch input. Remove wiring and reconnect end of line. Check released pressure switch circuit wiring. The Released Trbl LED will be accompanied by the front panel Flooding zone trouble LED to indicate a common trouble condition within the releasing agent section of the fire control panel.
<b>Low Pres Trbl</b>	A short or open circuit exists on the low pressure switch input. Remove wiring and re-connect the EOL. Check low pressure switch circuit wiring. The Low pres trouble LED will be accompanied by the front panel Flooding zone trouble LED to indicate a common trouble condition within the releasing agent section of the control panel.
<b>Tell Tale</b>	The panel mounted or remote manual release button has been pressed. Can only be reset by pressing processor reset and W/DOG reset or powering down the fire control panel.

This page intentionally left blank.

**Section 4**  
**Programming and Operating**

This section describes programming and operating the HCVR-3 Releasing Fire Control Panel.

**Programming the Fire Control Panel**

The HCVR-3 Releasing Fire Control Panel can be configured for almost any installation requirement. Navigate the menu on the System Mode LED display using the Select and Enter buttons of the HCVR-3 Releasing Fire Control Panel. The System Mode LED, Select and Enter buttons are located in the center of the front-panel fascia. Program the HCVR-3 Releasing Fire Control Panel in Access Level 3.

**Access Level 3**

To program the fire control panel in Access Level 3:

- 1 Set Access Level 2 by turning the Enable Access key to the right.
- 2 Move the Write Enable slide-switch to the right.

*The fire control panel beeps three-times to indicate entry in Access Level 3.  
 The beeping continues while in Access Level 3.*

The figure below illustrates the Write Enable switch on the fascia of the HCVR-3 Releasing Fire Control Panel:

**Figure 3-1**  
**Write Enable Switch**

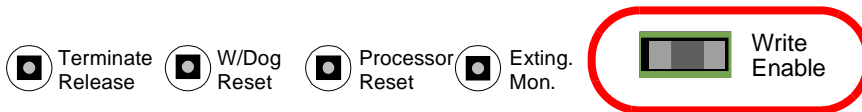

- 4 Press Mode and Select on the fascia to scroll through codes of the System Mode LED.
- 5 Press Enter to set the configuration code.

The figure below illustrates the Mode, Select, Enter and System Mode LED on the fascia of the fire control panel:

**Figure 3-2**  
**Mode, Select, Enter and System Mode LED**

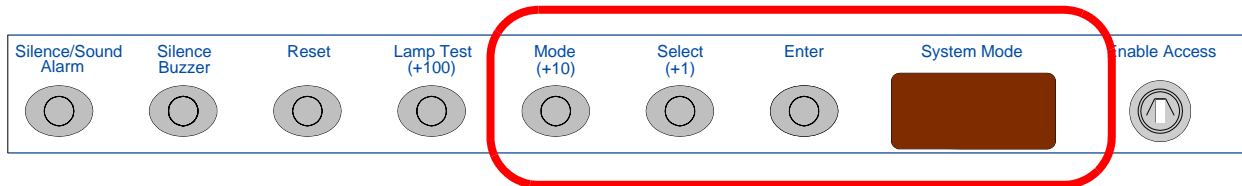

A flashing dot is displayed in the right corner of the The System Mode LED to indicate the set configuration code.

The figure below illustrates a “flashing dot” versus a “missing flashing dot” in the System Mode LED:

**Figure 3-3**  
**A “Flashing Dot” Versus A “Missing Flashing Dot”**

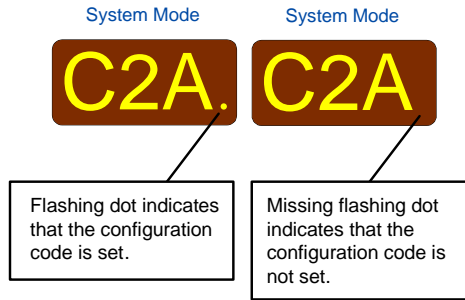

### Configuration Codes

Not all configuration codes of the HCVR-3 Releasing Fire Control Panel are authorized for operation under UL 864.

*Reference Appendix G, UL 864 Permitted Configurations for the list of authorized configuration codes of the HCVR-3 Releasing Fire Control Panel.*

The table below describes configuration codes of Access Level 3:

Code	Function	Description
UXX	Configuration update count	Number increments each time Access Level 3 configuration changes. Counter resets to 00 when 99 is reached.
C00	NAC delay time = 30 seconds	Introduces a time delay before NACs operate. Only one delay period can be selected. Delays are activated by the "Ad" option in Access Level 2.
C01	NAC delay time = 1 seconds	
C02	NAC delay time = 2 seconds	
C03	NAC delay time = 3 seconds	
C04	NAC delay time = 4 seconds	
C05	NAC delay time = 5 seconds	



Code	Function	Description
C06	NAC delay time = 6 seconds	
C07	NAC delay time = 7 seconds	
C08	NAC delay time = 8 seconds	
C09	NAC delay time = 9 seconds	
C11	Zone 1 & Zone 2 detectors trigger automatic release	Coincidence detection selection options. Only one option can be selected.
C12	Zone 2 & Zone 3 detectors trigger automatic release	
C13	Zone 1 & Zone 3 detectors trigger automatic release	
C14	Zone 1 & Zone 2 OR Zone 2 & Zone 3 OR Zone 1 & Zone 3 detectors trigger automatic release	
C15	Zone 1 & Zone 2 & Zone 3 detectors trigger automatic release	Coincidence detection selection options. Only one option can be selected.
C16	Zone 1 OR Zone 2 OR Zone 3 detectors trigger automatic release	
C17	Zone 1 detectors trigger automatic release	
C18	Zone 2 detectors trigger automatic release	
C19	Zone 3 detectors trigger automatic release	
C21	Disable Fire Buzzer	
C22	Disable Fire Output	Fire Relay
C23	Disable Trouble Output	Fire Relay

Code	Function	Description
<b>C24</b>	Disable Earth Trouble Monitoring	
<b>C25</b>	Pulse R0V Output	
<b>C26</b>	Remove AUX 24V on system reset	To enable resetting of system using AUX supply
<b>C27</b>	Indicate EXTING. released when EXTING. output is active	Rather than upon receipt of signal from flow switch.
<b>C28</b>	No Activation delay upon manual release	Delay remains active on automatic detection.
<b>C29</b>	Extinguishant output can be reset during imminent phase.	Allows extinguishant output to be reset before countdown timer has expired for installing and testing
<b>C2A</b>	LOCAL FIRE relay operates upon released signal	Local fire relay operates only when extinguishant is released rather than upon a fire condition
<b>C2b</b>	Extinguishant output on until reset	Extinguishant output remain on after release until panel is reset. (from software version 1.2 onwards only)
<b>C2C</b>	LOW P. SWITCH (Low pressure switch normally closed)	Low Pressure switch input normally looks for open contact closure on activation, enables normally closed switch to be used.
<b>C2D</b>	Delay the indication of a Power Trouble by 30 minutes	The Power Trouble indication is delayed by 30 minutes unless a Battery Low trouble exists. When a Battery Low trouble is reported, the delay of the Power Trouble indication is cancelled and the Power Trouble and Battery Low trouble are immediately reported.
<b>C31</b>	Zone 1 alarm from detector delayed	NAC outputs are delayed by time set at options 0-9 when zones are triggered by detector only. Any combination can be selected.
<b>C32</b>	Zone 2 alarm from detector delayed	
<b>C33</b>	Zone 3 alarm from detector delayed	

Code	Function	Description
C41	Zone 1 alarm from pull station delayed	NAC outputs are delayed by time set at options 0-9 when zones are triggered by pull station only. Any combination can be selected.
C42	Zone 2 alarm from pull station delayed	
C43	Zone 3 alarm from pull station delayed	
C61	Zone 1 operates through I.S. Barrier	Select only when detectors are connected to compatible I.S. barriers. Any combination can be selected.
C62	Zone 2 operates through I.S. Barrier	
C63	Zone 3 operates through I.S. Barrier	
C71	Zone 1 short circuit indicates alarm	Changes the trigger threshold of the zone so that the fire control panel can be used on older systems that do not have short circuit monitoring. Any combination can be selected.
C72	Zone 2 short circuit indicates alarm	
C73	Zone 3 short circuit indicates alarm	
C81	Zone 1 non-latching	Renders the zone self-resetting so that it can be used to receive signals from other systems and resets when the input is removed. Any combination can be selected.
C82	Zone 2 non-latching	
C83	Zone 3 non-latching	
CA1	Zone 1 device alarm must be present for 30 seconds	Input delay. Any combination can be selected.
CA2	Zone 2 device alarm must be present for 30 seconds	
CA3	Zone 3 device alarm must be present for 30 seconds	

Code	Function	Description
<b>E00</b>	Panel can be reset immediately after discharge output has operated	To allow reset of the panel to be prohibited before the extinguishant discharge has fully completed.
<b>E01 TO E29</b>	Panel can be reset 1 minute to 29 minutes after discharge output has operated	
<b>E30</b>	Panel can be reset 30 minutes after discharge output has operated	

<b>-00</b>	No extinguishant delay	Time delay between activation and extinguishant release output operating. This menu option is accessed using the lamp test (+100) button. The time is adjusted using the Mode button for 10's and the Select button for 5's. Once the time is selected the Enter button is used to store the value.
<b>-05</b>	5 second extinguishant delay	
<b>-10 TO -55</b>	Increment extinguishant delay in five second steps	
<b>-60</b>	60 second extinguishant delay	
<b>060</b>	Sets extinguishant duration time for 60 seconds	Time that extinguishant release output is activated. This menu option is accessed using the lamp test (+100) button. The time is adjusted using the Mode button for 10's and the Select button for 5's. Once the time is selected the Enter button is used to store the value. Panel can not be reset until this time has expired except by operating the terminate extinguishant switch located under the front cover.
<b>060 TO 295</b>	Increment extinguishant duration time in five second interval	
<b>300</b>	Sets extinguishant duration time for 300 seconds	

## Operating the Fire Control Panel

Access levels are provided for controls and programming on the HCVR-3 Releasing Fire Control Panel. Access Level 1 provides restricted controls, Access level 2 provides less restricted controls with limited programming and Access Level 3 provides unrestricted controls and programming.

### Access Level 2

To operate the HCVR-3 Releasing Fire Control Panel in Access Level 2:

- 1 Turn enable key-switch to get to access level 2.
- 2 Press Mode button until the required function is displayed in the System Mode LED.
- 3 Press the Select button to scroll to the required zone number then press Enter.

The “select dot” at the bottom of the System Mode LED flashes to confirm that the selected-function is active.

### Functions and Codes

Functions and codes for operating the HCVR-3 Releasing Fire Control Panel in Access Level 2 are described below:

Function	Terminal	Codes	Description
<b>Test Zones</b>	ZONE 1	t1	Select codes t1, t2 or t3 to place Zones 1, 2 or 3 in Test Mode. Zones in Test Mode automatically reset 3 seconds after operating. The Test Mode On and Zone Trouble/On Test/ Disabled indicators illuminate when zones 1, 2, or 3 are in Test Mode.
	ZONE 2	t2	
	ZONE 3	t3	
<b>Disable Zones</b>	ZONE 1	d1	Select codes d1, d2 or d3 to disable Zones 1, 2 or 3. Disabling Zones does not provide fire or trouble indications on the fire control panel. The General Disablement and Zone Trouble/On Test/Disabled indicators illuminate when zones 1, 2, or 3 are disabled.
	ZONE 2	d2	
	ZONE 3	d3	
<b>Disable NAC 1</b>	NAC1	db	Select the code db to disable the NAC1 output. The General Disablement and NAC Trouble/ Disabled indicators illuminate when NAC1 is disabled.
<b>Disable 1st Stage Relay</b>	1ST STAGE	dP	Select the code dP to disable the 1ST STAGE relay. The General Disablement indicator illuminates when the 1ST STAGE relay is disabled.
<b>Disable 2nd Stage Relay</b>	2ND STAGE	dA	Select the code dA to disable the 2ND STAGE relay. The General Disablement indicator illuminates when the 2ND STAGE relay is disabled.

Function	Terminal	Codes	Description
<b>Disable Extract Fan-Relay</b>	EXTRACT	dc	Select the code dc to disable the EXTRACT fan-relay. The Extract Fan Disabled indicator stops illuminating and the General Disablement indicator illuminates when the EXTRACT fan-relay is disabled.
<b>Disable Manual Release</b>	MAN. RELEASE	dt	Select the code dt to disable the MAN. RELEASE input. The General Disablement indicator illuminates when the MAN. RELEASE input is disabled.
<b>Disable Extinguishant Release</b>	EXTING.	dE	Select the code dE to disable the pre-release timer and EXTING. output. Extinguishant output trouble conditions are ignored when the extinguishant release is disabled.
<b>Active Delays</b>		Ad	Select the code Ad to activate delays with Access Level 3 options C00 to C09.
<b>Close Extract Fan Contacts</b>	EXTRACT	Ac	Select the code Ac and press the Enter button on the fascia of the HCVR-3 Releasing Fire Control Panel to close the normally-open contacts of the EXTRACT terminals. Press the Enter button again while operating the code Ac and contacts of the EXTRACT terminals open.

## Control Operation

The table below describes control operation of the HCVR-3 Releasing Fire Control Panel:

Controls	Operation
<b>Terminate Release</b>	Press the Terminate Release button while in Access Level 3 to terminate the flow of extinguishant caused by a releasing event and reset the fire control panel. The flow of extinguishant can not be stopped using the reset button until after the extinguishant duration timer has elapsed.
<b>W / Dog Reset</b>	Press the W / Dog Reset button to clear the watchdog event. The watchdog event causes a reset when the fire control panel fails to carry out an operation. The following conditions occur during a watchdog event: <ul style="list-style-type: none"> <li>• The General Trouble and System Trouble LEDs light in the General System Status area of the upper indicators.</li> <li>• The CPU Trbl. (trouble) LED lights on the lower indicators of the fascia.</li> <li>• The internal buzzer of the fire control panel sounds.</li> </ul>

Controls	Operation
<b>Processor Reset</b>	Press the Processor Reset button to reset the function of processors in the HCVR-3 Releasing Fire Control Panel. Perform this task to restore normal operation to the fire control panel. The fire control panel will resume normal operation within seconds of pressing the processor reset button. This task is not a typical function of the fire control panel and is only necessary when controls and indicators are unresponsive. Press the Processor Reset after a firmware upgrade to re-initialize processors in the fire control panel.
<b>Exting. Mon.</b>	Potentiometer used for calibrating the releasing circuit. <i>Reference the Releasing Calibration area of this section for further information.</i>
<b>Write Enable</b>	To operate the Write Enable switch: <ol style="list-style-type: none"> <li>1 Turn the Enable Access key to the right to open Access Level 2.</li> <li>2 Move the slide-switch to the right to select Access Level 3. Place this switch in the Write Enable position when programming in Access Level 3.</li> <li>3 Return the slide-switch to the non-Write Enable position after completing tasks in Access Level 3.</li> </ol>

### Single Zone Fire Condition

Upon receipt of a fire condition by activation of a detector or pull station, the *Common Fire* indicator will light and the zonal *Fire* indicators will flash at around 2Hz. The fire and local fire relays will also operate and signal any systems to which they are connected. Any annunciators connected to NAC1 and NAC2 will operate. If the zone that has activated is contributing to the extinguishant release sequence, the First stage activated LED will light and the first stage relay contact will operate.

### Double Zone Fire Condition

Upon receipt of a second fire condition when the control panel is switched to Automatic and Manual mode, the Abort input is not active, and the Disable Extinguishant Sub-system function has not been invoked, the control equipment will respond as above and as listed below:

- The second stage alarm output will operate. (NAC circuit S3)
- The 2<sup>nd</sup> stage contact will operate.
- The release imminent indicator will operate
- The seven segment LED displays will indicate the time remaining until release in seconds.
- The extinguishant output will operate after the configured delay time and for the configured duration after which it shall de-activate.

*The fire control panel can reset a releasing count-down if the reset is performed before zero (0) and all inputs are clear of alarm conditions. The reset of the releasing count-down can be performed while operating the fire control panel in Access Level 2.*

## Abort Function

Abort is a temporary function that suspends the releasing count-down after contacts on a momentary-switch are closed. Suspension of the releasing count-down occurs at 10 seconds. Activating the abort function prior to 10 seconds continues the releasing count-down until the timer reaches 10 seconds.

Activating the abort function after 10 seconds causes an immediate suspension of the releasing count-down and the timer holds at 10 seconds. The releasing count-down re-starts at 10 seconds when contacts on the momentary-switch are opened. A releasing event occurs when the count-down timer reaches zero. An abort function overrides a manual release function when the manual release is activated before the abort. The manual release function overrides the abort function when the abort is activated before the manual release.

## Silence/Sound Alarms

The *Silence/Sound alarm* button can only be operated at access level two which means that the *Enable Control* key must be inserted and turned to the right. To silence the NACs, insert the Enable Control key, turn to the right and press the Silence/Sound alarm button.

When the NACs have been silenced, the Zone Fire LEDs will change from flashing to a steady state. Pressing the *Silence/Sound alarm* whilst the fire control panel is in this silenced condition, will cause the NACs to operate again. The NACs can be toggled on and off with the *Silence/Sound alarm* button as required.

## Reset

The reset command restores operation of the HCVR-3 Releasing Fire Control Panel from alarm and trouble conditions. Latched inputs of the extinguishant circuit are reset after the countdown timer expires. The reset command can be configured to operate before the countdown timer has expired. The configuration programs the command to reset the extinguishant output during the imminent release phase.

*Reference Configuration Code, C29 of this section to program the reset command to operate during the imminent release phase of the extinguishant output.*

The reset command can be operated with or without activation of the Trouble Relay.

To reset the fire control panel without activation the Trouble Relay:

- 1 Turn the key of the Enable Access to the right to obtain Access Level 2 of the menu.
- 2 Press the Reset button for less than ten seconds.

The fire control panel will restore from the alarm or trouble condition and the Trouble Relay will not activate.

To reset the fire control panel with activation of the Trouble Relay:

- 1 Turn the key of the Enable Access to the right to obtain Access Level 2 of the menu.
- 2 Press the Reset button for ten seconds or more.

The fire control panel will restore from the alarm or trouble condition and the Trouble Relay will activate ten seconds after operation of the reset command.



## Zone Trouble

Removal of a detector from its base or a trouble on any of the zone wiring will cause the *Trouble* LED and *Zone Trouble* LEDs to flash, indicating the zone in which the trouble has occurred.

## NAC Trouble

A trouble on the wiring to sounder circuits will cause the *Trouble* and *NAC Trouble* LEDs to flash, indicating a trouble on the wiring to the sounder circuits.

## Power Trouble

Failure of the mains power or disconnection of the standby battery will cause the *Trouble* and *Power Trouble* LEDs to light indicating an abnormality in the power supply to the fire control panel.

## System Trouble

The *System Trouble* LED will light if the configuration memory has not been set or has become corrupt.

## General Trouble

Will illuminate under any trouble condition. This LED will also light if the configuration option jumper (see figure 18) has been left in the access level 3 position and the enable controls key has been removed from the front panel.

## Lamp Test

All LED indicators can be tested at any time by pressing the *Lamp Test* button. The *Enable Control* key does not need to be inserted to test the indicators. The buzzer can be silenced at any time by pressing the *Buzzer Silence* button. The enable key does not need to be inserted to silence the buzzer.

## Released Condition

The released pressure switch input is connected to a pressure switch mounted on the extinguishant cylinder that operates when the extinguishant is released. This process activates the released indicator on the fire control panel.

The fire control panel is not in an activated condition when the extinguishant releases by mechanical means.

## Low Pressure Switch

The Low Pressure Switch input on the fire control panel is connected to a pressure switch on the extinguishant cylinder which will operate if the pressure in the cylinder falls below a set point. This will happen after the extinguishant has been released but may happen before release through a leak.

The flooding zone trouble indicator will light and the buzzer will sound when this input is operated. The pressure switch can be configured as normally open or normally closed via configuration option C2C (software version 1.2 and above only).

## Test mode

Fire alarm systems must be tested regularly to ensure that they are functioning correctly. The system can be tested single handed by using a test mode. When in test mode, activation of a fire alarm is automatically reset after a few seconds to eliminate the need to return to the fire control panel to reset after every activation. Test mode is entered in a similar way to disablements.

With the *Enable Control* key inserted, press the *Mode* button until "t" appears in the first of the seven segment displays. Then press the *Select* button until the required zone number appears. Pressing the *Enter* button will cause the *Test* and *Zone Trouble* LEDs to illuminate indicating the zones which are in test mode. Disablements and zone tests are cleared by repeating the sequence that is used to select them. The "db" function for example, toggles between NACs disabled and NACs enabled.

## Change mode

The mode of the system can be toggled between Manual Only and Automatic & Manual by operating the key-switch in the extinguishant status area of the panel. When the system is in Manual Only mode, the extinguishant cannot be released by the operation of automatic detectors.

*The mode can also be changed to manual by the external mode select input or the key-switch on any status unit. Any mode select input to manual mode will override any key-switches switched to Automatic and Manual mode.*

## Extract fan

When the extract function is selected by access level 2 option Ac, the extract contact in the panel and at all ancillary boards will operate. When active the display shows a flashing dot after the Ac.display. If the panels enable control key is switched off when the extract output is active, the display will show "ccc".

Turning on the Enable Control key will not automatically display the menu options if the "ccc" message is present. The Ac. display can be shown by pressing the Mode button, followed by the Enter button to clear the event.

## Disablements

Disablements of the fire alarm system prevent false alarm conditions when performing building maintenance or construction.

## Disabling and Enabling Zones

This section describes disabling and enabling zones. Disable zones for testing and troubleshooting. Enable zones for operation following the disabling process. Zones are enabled as a default function of the fire control panel.

### Disabling Zones

To disable zones on the HCVR-3 Releasing Fire Control Panel:

- 1 Turn the key of the Enable Access to the right to obtain Access Level 2 of the menu.
- 2 Press the Mode button until "d" appears in the first field of the LED display.
- 3 Press the Select button to choose the zone number for disabling.  
*The zone number appears in the second field of the LED display.*
- 4 Press the Enter button to set the disabled zone.  
*A dot appears in the lower-right corner of the LED display to identify the disabled zone.  
The Zone Trouble/ On Test/ Disabled LED will light on each disabled zone.*

### Enabling Zones

The HCVR-3 Releasing Fire Control Panel includes a feature that identifies a zone in a trouble condition. The feature alerts operators of the trouble condition before the zone is enabled. The zone number flashes in the second field of the LED Display to identify the trouble condition in the zone.

Enabling a zone in a trouble condition will cause the fire control panel to activate an alarm. Disabling the troubled zone after alarm activation will not silence the alarm. Correct the circuit causing the trouble condition in the zone and then reset the fire control panel to prevent or eliminate activation of the alarm.

*Reference Reset of this section for more information regarding the Reset command of the HCVR-3 Releasing Fire Control Panel.*

To enable zones on the HCVR-3 Releasing Fire Control Panel:

- 1 Turn the key of the Enable Access to the right to obtain Access Level 2 of the menu.
- 2 Press the Mode button until "d" appears in the first field of the LED display.
- 3 Press the Select button to choose the zone number for enabling.  
*The zone number appears in the second field of the LED display. A dot appears in the lower-right corner of the LED display to identify the disabled zone. The zone number flashes when a trouble condition exists.*

### CAUTION!



The HCVR-3 Releasing Fire Control Panel activates an alarm when a zone in trouble is enabled. Use the zone in trouble feature of this control panel to identify the troubled zone before enabling it. Correct the circuit causing the trouble condition in the zone and then reset the fire control panel to prevent or eliminate the alarm condition.

- 4 Press the Enter button to activate the zone.  
*A dot does not appear in the lower-right corner of the LED display. The Zone Trouble/ On Test/ Disabled LED indicator is not illuminated. Zones of the fire control panel are enabled when these conditions are satisfied.*

### **Disable NAC Outputs**

To disable NAC outputs, press the mode button to select “db” on the seven segment display. Pressing enter will disable all NAC outputs and cause the General Disablement and NAC Trouble/ Disabled LEDs to light.

### **Activate Delays**

To activate delays on zones as set in configuration options 31 to 33 and 41 to 43, press the mode button until ad appears on the seven segment LED display. When the enter button is pressed any zones that are set as delayed will have their alarm outputs delayed by the time set in configuration options C00 to C09.

### **Disable Trouble Contact**

The trouble relay can be disabled by selecting configuration option C23.

*Reference additional disablement options in Functions and Codes of this section.*

### **Disable Extinguishant Subsystem**

The 2<sup>nd</sup> stage relay, 2<sup>nd</sup> stage alarm output and extinguishant release output can be disabled together by selecting “dE” from the access level 2 options.

*Reference additional disablement options in Functions and Codes of this section.*

### **Disable 1<sup>st</sup> Stage Contact**

The first stage contact can be disabled by selecting configuration option “dP”.

*Reference additional disablement options in Functions and Codes of this section.*

### **Disable 2<sup>nd</sup> Stage Contact**

The Second stage contact can be disabled by selecting configuration option “dA”.

*Reference additional disablement options in Functions and Codes of this section.*

### **Disable Manual Release**

The Manual release facility can be disabled by selecting configuration option “dT”.

*Reference additional disablement options in Functions and Codes of this section.*

### **Disable Extract Fan**

The extract fan output can be disabled by selecting configuration option “dC”.

*Reference additional disablement options in Functions and Codes of this section.*

## Relay Operation

The HCVR-3 Releasing Fire Control Panel provides volt free changeover relay contacts for local control and signalling. The relay contacts are rated for switching signalling circuits only and the maximum ratings should not be exceeded under any circumstances.

*Reference Appendix A, Specifications for relay ratings and operating characteristics.*

Relays of the HCVR-3 Releasing Fire Control Panel are common and not programmable and include:

<b>Trouble Relay</b>	The trouble relay is normally energized and will de-energise during trouble conditions, including the total loss of power. <i>The Trouble Relay can be activated or de-activated during the reset command. Reference Reset of this section for setting the operating condition of the Trouble Relay during Reset activation.</i>
<b>Local Fire Relay</b>	The local fire relay energizes during activation of a fire condition on any zone or by pressing the sound alarm button in level 2 on the fascia. The relay remains activated until the alarm is silenced or the fire control panel is reset.
<b>Fire Relay</b>	The fire relay energizes during activation of a fire condition on any zone or by pressing the sound alarm button in level 2 on the fascia. The relay remains activated until the fire control panel is reset.
<b>1st Stage Alarm</b>	The first stage alarm operates during activation of a zone that has been configured to contribute to the releasing decision and de-activates when the fire control panel has been reset. This relay also operates during activation of the manual release switch.
<b>2nd Stage Alarm</b>	The second stage alarm relay operates when the fire control panel enters the activated condition and de-activates when the fire control panel has been reset from the released condition. The fire control panel can enter the activated condition and operate the second stage relay when the releasing countdown timer has started.
<b>Extract Relay</b>	The extract relay operates when the Ac option is selected at access level 2. This process vents releasing gases from a room and prevents gases from being vented during discharge.

## Calibrating the Releasing Circuit

Calibrate the releasing circuit by adjusting the EXTING. MON. potentiometer on the front-panel of the of the HCVR-3 Releasing Fire Control Panel. Adjust the EXTING MON setting to provide supervision of the “EXTING.” output with the field wiring complete.

To perform the calibration:

- 1 Verify that the EXTING voltage output is in the range of (-0.2 to -1.0 volts).  
(If not, check field wiring and polarity of EOLD.)
- 2 Verify that, when activated, the voltage drop from the EXTING output terminals to the releasing device (and EOLD) is less than the permitted 2.4 volts.
- 3 If the panel is indicating an active Releasing Trouble, turn the Exting Mon adjustment clockwise until the Releasing Trouble clears.
- 4 If the panel is indicating no Releasing Trouble, turn the Exting Mon adjustment counter-clockwise until the Releasing Trouble activates.
- 5 Once at this threshold, turn the Exting Mon adjustment one full turn clockwise.
- 6 Verify that a short circuit at the releasing device results in a Releasing Trouble indication at the panel.

## Section 5

# Maintenance and Repair

---

This section provides procedures for maintaining and repairing the HCVR-3 Releasing Fire Control Panel.

## Cleaning the External Cabinet and Door

Clean the external cabinet and door of the HCVR-3 Releasing Fire Control Panel with a damp cloth. Do not clean these surfaces with detergents or solvents. Do not permit water to enter the cabinet during the cleaning process.

## Testing the Releasing System

Test the releasing system periodically to confirm operation. Perform the test with the appropriate isolation measures in place to prevent the accidental discharge of the releasing agent. Testing of the releasing system must be performed by trained personnel.

## Inspecting Batteries

Inspect the standby-batteries annually to determine the connection integrity to the HCVR-3 Releasing Fire Control Panel. The fire control panel contains sealed lead acid batteries to provide standby power in the event of mains failure. The standby-batteries have a life expectancy of 3 to 5 years. Test the standby-batteries annually in accordance with the battery manufacturer's recommendations to determine their suitability for continued standby operation.

## Replacing Standby-Batteries

Replace standby-batteries when the service period reaches 3 to 5 years or when the low-battery indicator illuminates on the power supply. Specify replacement batteries that are sealed-lead-acid.

## Removing the Standby-Batteries

To remove the existing standby-batteries:

- 1 Disconnect the jumper-lead between the standby-batteries.
- 2 Disconnect the red-lead from the positive terminal of one standby-battery.
- 3 Disconnect the black-lead from the negative terminal of the other standby-battery.
- 4 Remove the standby-batteries from the bottom of the HCVR-3 Releasing Fire Control Panel cabinet.
- 5 Re-cycle the standby-batteries according to manufacturer instructions.

## Installing the Standby-Batteries

*Reference Section 3, Installation for installing the standby-batteries.*

## Replacing Fuses

The HCVR-3 Releasing Fire Control Panel contains a battery fuse and an AC input fuse to protect it against circuit overloads. The battery fuse is a 3.0 Amp slow blow and the AC input fuse is a 1.6 Amp slow blow.

*Reference Section 1, Installation Wiring, Rechargeable Battery Circuit for more information about the battery fuse.*

*Reference Section 1, Installation Wiring, Main Supply Circuit for more information about the AC input fuse.*

During the life of the product it may be necessary to replace one or both of the fuses to restore operation.

*Replace a fuse only after diagnosing and replacing components responsible for causing the fuse failure. Fuse failure is not a condition caused by the fuse. Diagnose and replace components in the circuit before replacing the fuse and then test the HCVR-3 Releasing Fire Control Panel for proper operation.*

## Battery Fuse

The following procedures describe methods for removing and installing the battery fuse of the HCVR-3 Releasing Fire Control Panel.

To remove the battery fuse:

- 1 Turn off 115 VAC or 230 VAC at the power source.
- 2 Unlock and then open the door of the HCVR-3 Releasing Fire Control Panel.
- 3 Disconnect the red-lead of the recharging circuit from the positive terminal of the standby-battery.
- 4 Disconnect cabling connections at the EXTING. terminals of the HCVR-3 Releasing Fire Control Panel.
- 5 Remove two retaining-screws securing the fascia to the cabinet of the HCVR-3 Releasing Fire Control Panel.
- 6 Remove the fascia from the cabinet of the HCVR-3 Releasing Fire Control Panel.
- 7 Rotate the fascia so that the printed-circuit-board side of the assembly is facing up.
- 8 Locate the fuse housing on the printed-circuit-board that contains the battery fuse.
- 9 Remove the upper-half of the fuse-housing by grasping and pulling upward at the center of fuse-housing.
- 10 Remove the battery fuse from the upper-half of the fuse-housing



### Installing the Battery-Fuse

To install the Battery-Fuse:

- 1 Confirm that cabling connections at the EXTING. terminals are disconnected.
- 2 Confirm that 115 VAC or 230 VAC is turned-off at the power source.
- 3 Confirm that the red-lead of the recharging circuit is disconnected from the positive terminal of the standby-battery.
- 4 Install the replacement fuse in the upper-half of the fuse-housing.
- 5 Connect the upper-half to the lower-half of the fuse-housing.
- 6 Secure the fascia to the cabinet of the HCVR-3 Releasing Fire Control Panel using the two retaining-screws.
- 7 Re-connect the red-lead of the recharging circuit to the positive terminal of the standby-batteries.
- 8 Re-connect cabling to the EXTING. terminals of the HCVR-3 Releasing Fire Control Panel.
- 9 Close and lock the door of the HCVR-3 Releasing Fire Control Panel.
- 10 Turn on 115 VAC or 230 VAC at the power source.
- 11 Test the fire control panel by operating it to determine that it functions.

### AC Input Fuse

The following procedures describe methods for removing and installing the AC input fuse of the HCVR-3 Releasing Fire Control Panel.

#### Removing the AC Input Fuse

To remove the AC input fuse:

- 1 Disconnect cabling connections at the EXTING. terminals of the HCVR-3 Releasing Fire Control Panel.
- 2 Turn off 115 VAC or 230 VAC at the power source.
- 3 Unlock and then open the door of the HCVR-3 Releasing Fire Control Panel.
- 4 Remove the AC input fuse from the terminal block housing.

### **Installing the AC Input Fuse**

To install the AC Input Fuse:

- 1 Confirm that cabling connections at the EXTING. terminals are disconnected.
- 2 Confirm that 115 VAC or 230 VAC is turned-off at the power source.
- 3 Install the replacement fuse in the terminal block housing.
- 4 Re-connect cabling to the EXTING. terminals of the HCVR-3 Releasing Fire Control Panel.
- 5 Close and lock the door of the HCVR-3 Releasing Fire Control Panel.
- 6 Turn on 115 VAC or 230 VAC at the power source.
- 7 Test the fire control panel by operating it to determine that it functions.

### **Replacing Cabinet Components**

*Reference General Wiring Information when replacing components of the HCVR-3 Releasing Fire Control Panel.*

## Section 6

# Supplementary Devices

---

This section provides procedures for installing and operating supplementary devices of the HCVR-3 Releasing Fire Control Panel.

*Reference Appendix A, Specifications to identify operating parameters of these devices.*

## Status Display Units

Status Units extend indications and controls of the HCVR-3 Releasing Fire Control Panel to other locations within the fire protection system to make operation of the system more practical. A maximum of seven Status Units can be connected to each HCVR-3 Releasing Fire Control Panel in a releasing area.

Status Units are supervised for open-circuit, short-circuit and ground-fault conditions. Status Units are compatible with all models of the HCVR-3 Releasing Fire Control Panel. The Status Unit requires a data connection and 24 VDC to operate. Status Units can also be powered by the AUX 24V output or an auxiliary 24 VDC source that is listed for Fire Applications with Regulated and Power Limited Outputs. The maximum line impedance is 120 Ohms.

## The J2 Jumper Connection

Status Units contain a push-on-jumper at PCB location J2. The J2 jumper is located on the left-side of the Status Unit PCB. The J2 jumper is a terminating resistor for establishing the end of the data line. Connect the J2 jumper to the last Status Unit when multiple Status Units are connected in a data line. Connect the J2 jumper when operating one Status Unit.

*A common earth ground is required between all Status Units and each fire control panel. Maintain correct polarity when connecting the Status Unit to the HCVR-3 Releasing Fire Control Panel. Status Unit terminal-connections are polarity sensitive.*

The figure below illustrates Status Unit J2 jumper connections:

**Figure 6-1**  
**Status Unit - J2 Jumper Connections**

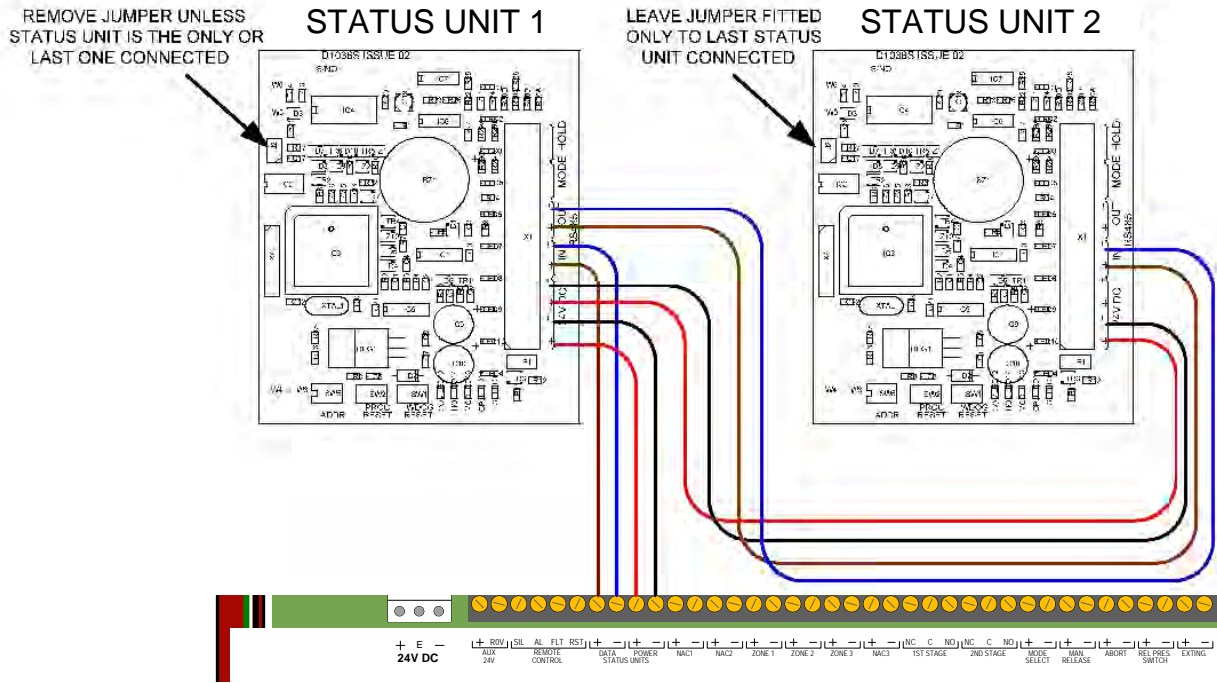

The figure below illustrates an example of three Status Unit connections:

**Figure 6-2**  
**Example of Three Status Unit Connections**

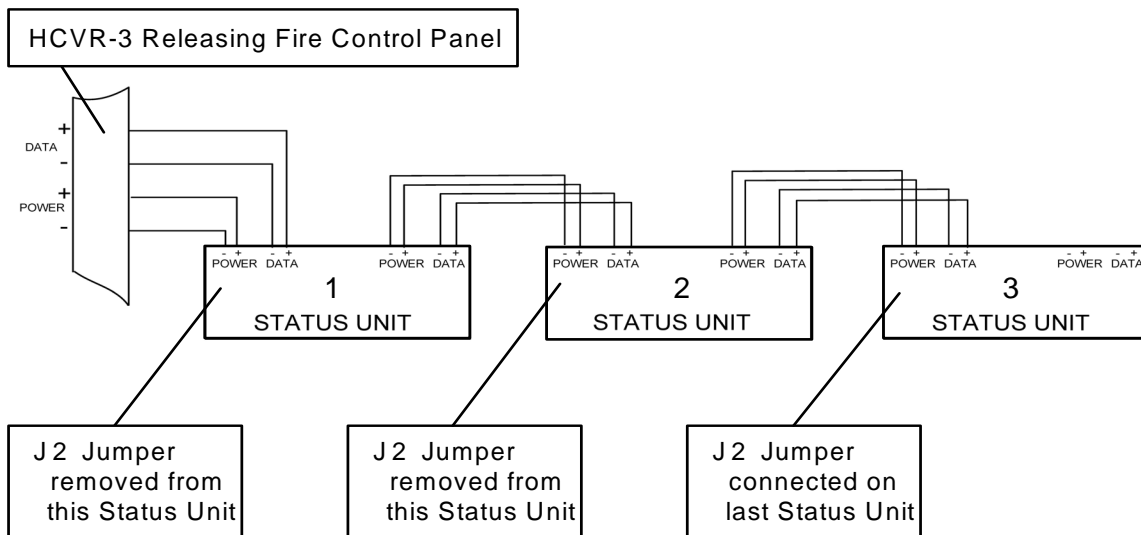

## Abort Connections

Abort connections of the Status Unit are supervised for open-circuit, short-circuit and ground-fault conditions.

*Abort connections on the circuit board of the Status Unit are labeled Hold. Hold and Abort functions are identical.*

To provide supervised connections on the Abort terminals:

- 1 Connect a 470 Ohm trigger-resistor, 0400-03150 in series with one-leg of the normally open switch.
- 2 Connect a 6.8 K Ohm EOL resistor, 0400-03140 in parallel with the normally-open-switch.
- 3 Connect wiring from one-side of the 6.8 K Ohm EOL resistor, 0400-03140 to one-side of the Hold input.
- 4 Connect wiring from the opposite-side of the 6.8 K Ohm EOL resistor, 0400-03140 to the opposite-side of the Hold input.

*Connect the 6.8 K Ohm EOL resistors across the Hold terminals of the Status Unit when inputs are unused.*

The figure below illustrates Hold connections for the Status Unit:

**Figure 6-3**  
**Hold Input Connections**

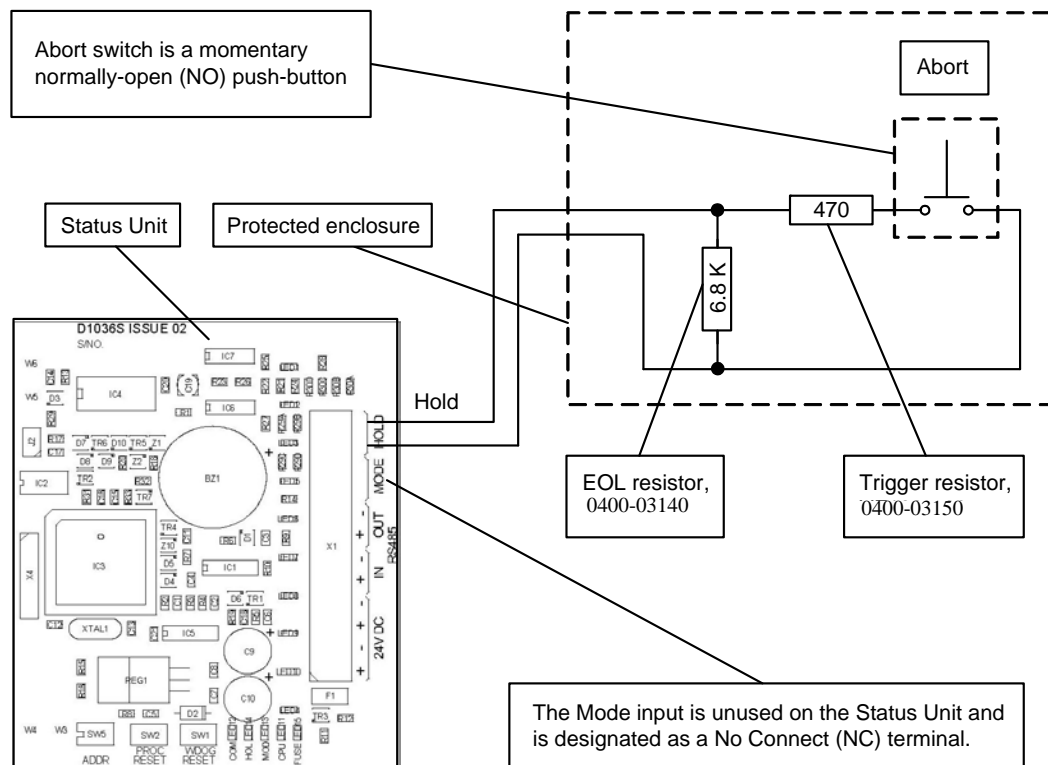

Two 6.8 K Ohm EOL resistors, 0400-03140 and two 470 Ohm series-resistors, 0400-03150 are supplied with each Status Unit assembly. The 6.8 K Ohm EOL resistors, 0400-03140 are connected to the Hold input terminals during the shipping process. The 470 Ohm series-resistors, 0400-03150 are provided in an accessory-bag included with the status unit packaging.

*Reference Abort switch HCVR-AS or equivalent.*

## Mode Input

The Mode input is unused on the Status Unit and is designated as a No Connect (NC) terminal.

## Hold Input

*Abort connections on the Status Unit are labeled Hold. Hold and Abort functions are identical.*

*Reference Section 4, Programming and Operating for a complete description of the abort function.*

## Mode Select Key Switch

Certain models of the status unit have a Mode select key-switch. The key can only be removed in the “Automatic and Manual” position. The system is placed in manual only mode when any mode input is activated regardless of the status of other mode inputs. Therefore, all mode inputs must be inactive for the system to be in Automatic or Manual Mode.

*The system can include the HCVR-3 Releasing Fire Control Panel, IDCs, Status Display Units and Ancillary Boards.*

LED indicators on the front-panel of the Status Unit illuminate when the key-switch is in the “Automatic and Manual Only” or “Manual Only” position.

## Ancillary Board

The ancillary board provides additional outputs and voltage free contacts for operating with the HCVR-3 Releasing Fire Control Panel. The Ancillary board is compatible with all models of the HCVR-3 Releasing Fire Control Panel. Up to 7 ancillary boards can be connected to a fire control panel and each is allocated an address from 1 to 7 using a binary coded DIL switch.

*The ancillary board is intended to provide additional signalling and control for the HCVR-3 Releasing Fire Control Panel only.*

The ancillary board requires a data connection and 24 VDC to operate. Status Display Units can also be powered by the AUX 24V output or an auxiliary 24 VDC source that is listed for Fire Applications with Regulated and Power Limited

Outputs. The maximum line impedance is 120 Ohms.

## The J2 Jumper Connection

Ancillary Boards contain a push-on-jumper at PCB location J2. The J2 jumper is located on the left-side of the Ancillary Board PCB. The J2 jumper is a terminating resistor for establishing the end of the data line. Connect the J2 jumper to the last Ancillary Board when multiple Status Units are connected in a data line. Connect J2 jumper when operating one Ancillary Board.

*A common earth ground is required between all Status Units and each fire control panel.*

**Hochiki America Corporation**  
**HCVR-3 Series - Conventional Fire Alarm Releasing System**  
**Installation and Operation Manual, HA-06-294, Version V02.10**

The figure below illustrates the J2 Jumper location on the Ancillary Board:

**Figure 6-4**  
**J2 Jumper Location**

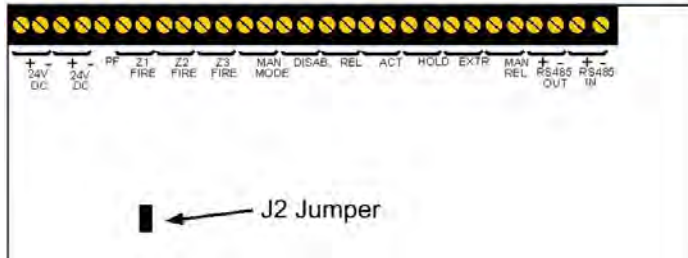

## Relay Contacts

Relay contacts of the Ancillary Board provide volt free changeover relay contacts for local control and signalling. The relay contacts are rated for switching signalling circuits only and the maximum ratings should not be exceeded under any circumstances.

Relay contact of the Ancillary Board include:

- |                          |   |
|--------------------------|---|
| <b>Zonal Fire Relays</b> | Zonal fire relays on the Ancillary Board are labelled Zone 1 FIRE, Zone 2 FIRE and Zone 3 FIRE. The zonal fire relays operate in conjunction with the activation of zones 1 to 3 on the fire control panel. Zonal fire relays remain activated until the fire control panel is reset. |
| <b>MAN MODE Relay</b>    | The MAN MODE relay operates when the extinguishant system is switched to manual only mode and switches off when the system is switched to Automatic and manual mode.  |
| <b>DISAB Relay</b>       | The DISAB relay operates when the extinguishant system is disabled via access level 2 option [dE].  |
| <b>REL Relays</b>        | The REL relay operates when the released condition has been established at the fire control panel.  |
| <b>ACT Relay</b>         | The ACT relay operates when the activated condition (extinguishant release countdown) has been established at the fire control panel.   |
| <b>HOLD Relay</b>        | The HOLD relay operates when the system is in the Hold condition.   |
| <b>EXTR Relay</b>        | The EXTR relay operates when the fire control panel is operating the extract fan output.  |
| <b>MAN REL Relay</b>     | The MAN REL relay operates when a manual release input occurs on the fire control panel.  |

## Connecting Power

The Ancillary Board requires 24 VDC to operate. Provide this 24 VDC power from the AUX 24V or the STATUS UNIT, POWER terminals of the HCVR-3 Releasing Fire Control Panel.

The total current obtained from connecting multiple Ancillary Boards and Status Units to the HCVR-3 Releasing Fire control panel must be below the maximum ratings of the AUX 24V or STATUS UNIT, POWER outputs.

If the total current required by the connection exceeds these maximum fire control panel ratings then a separate power source must be used that is capable of providing this current level.

*Reference Appendix A, Specifications for ratings of the AUX 24V, STATUS UNIT and POWER terminals.*

Two-sets of terminals are provided for 24 VDC wiring on the Ancillary Board. Connect incoming 24 VDC wiring to one set of the two terminals. Connect out-going 24 VDC wiring to the remaining set of two-terminals. Out-going wiring of the Ancillary Board can include additional Ancillary Boards or Status Units.

## 24 VDC Terminals

The figure below illustrates two-sets of 24 VDC terminals on the Ancillary Board:

**Figure 6-5**  
24 VDC Terminals

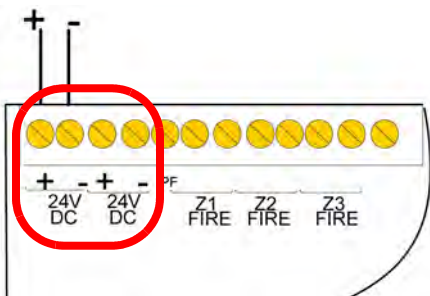

## Connecting Data

The figure below illustrates RS485 data connections of the Ancillary Board:

**Figure 6-6**  
RS485 Data Connections of the Ancillary Board

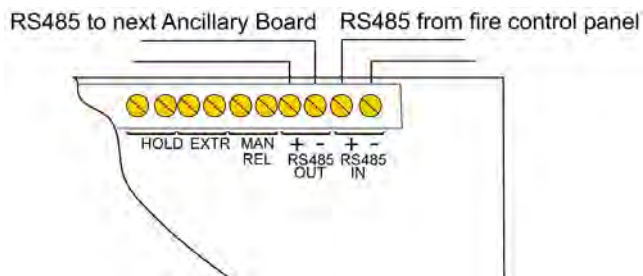



The figure below illustrates an example Ancillary Board connection containing two Status Units:

**Figure 6-7**  
**Example Ancillary Board Connection**

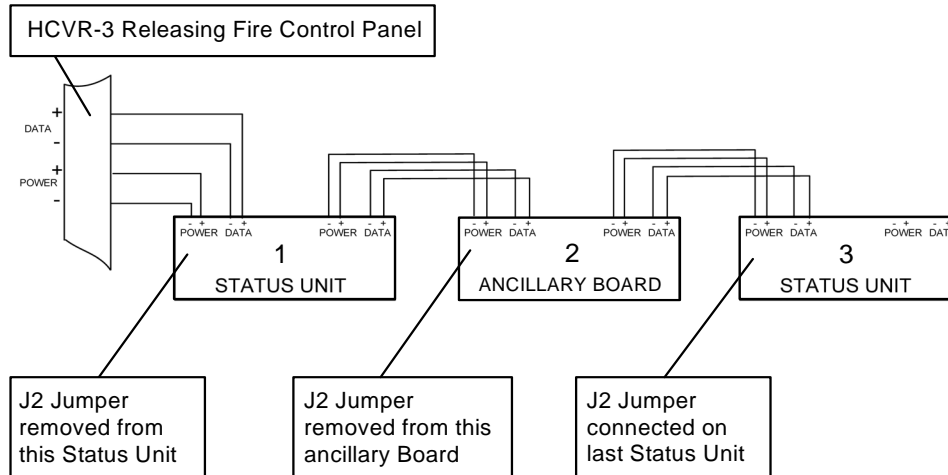

### Power Fault (PF)

Power Fault (PF) is unused on the Ancillary Board and is designated as a No Connect (NC) terminal.

## Configuring Status Units and Ancillary Boards

Status units and ancillary boards require a four-wire connection from the fire control panel, which drops into each unit and connects to the corresponding data and power, in and out terminals. Two of the cables carry power to the units (24V) and the other two carry data. A four core cable suitable for carrying RS485 data should be used.

Each status unit has a 3-bit DIP switch and must be allocated a unique address between 1 and 7. Each ancillary board has a 3-bit DIL switch and must be allocated a unique address between 1 and 7. The address switch is located on the bottom left hand corner of the status unit or ancillary board PCB.

The address is only read when the boards are first powered so address switches should not be altered on a system that has power applied. If a double address occurs on the system then the system will illuminate the General Trouble and Abort indicators and the buzzer will sound. The panel display will show the status unit or ancillary boards that have the same address.

The figure below illustrates DIP switch settings on the Status Display Unit and Ancillary Board:

**Figure 6-8**  
**DIP Switch Settings**

Status Unit Address	DIP Switch Number		
	1	2	3
1	●	○	○
2	○	●	○
3	●	●	○
4	○	○	●
5	●	○	●
6	○	●	●
7	●	●	●

● = Switch ON/UP

Ancillary Board Address	DIP Switch Number		
	1	2	3
8	●	○	○
9	○	●	○
10	●	●	○
11	○	○	●
12	●	○	●
13	○	●	●
14	●	●	●

● = Switch ON/UP

## Adding Status Display Units and Ancillary Boards

When the system is powered, it will search for connected status units and/or ancillary boards. When new or additional status display units/ancillary boards are added to the system, these will be shown on the display when the system is first powered.

Status Display Units are shown as Pux and ancillary boards are shown as Pox (where x is the address of the unit found). The select key can be used to view all of the status display units/ancillary boards that the system has found. These should be checked to ensure that the same number of devices that have been connected are found by the system.

For the system to accept these into its memory, the procedure below must be followed.

- 1 Operate the Enable Controls key-switch.
- 2 Enable the Write Enable Switch (push to the right) – Access level 3.
- 3 The display will show Pux for status display units and Pox for ancillary boards that are found (where x is the address of each unit) and the dot in the display will be flashing. Operate the Enter button which will accept the displayed unit and step through to the next unit found.
- 4 When the Enter button does not step on to any other units, all devices have been accepted.
- 5 Disable the Write enable switch (push to the left).
- 6 Disable the Enable controls key-switch.
- 7 The panel should return to the normal, quiescent condition.

## Removing Status Display Units and Ancillary Boards

When status display units/ancillary boards are to be removed from the system, the system must be powered down first and the status display units/ancillary boards removed. The system should then be powered. When the system starts it will be in trouble and the units removed will be shown on the display. Status display units are shown as Fux and ancillary boards are shown as Fox (where x is the address of the unit). The Select button can be used to view all of the status display units/ancillary boards that the system expects to be found but are now missing.

For the system to accept the removal of these devices from its memory the following procedure must be carried out.

- 1 Operate the Enable Controls key-switch.
- 2 Enable the Write Enable Switch (push to the right) – Access level 3.
- 3 Wait for the General trouble LED to illuminate
- 4 Disable the Write enable switch (push to the left)
- 5 Disable the Enable controls key-switch
- 6 The panel should return to the normal quiescent condition.

If the panel fails to receive messages from a status unit or ancillary board after it has been stored in the configuration memory, the internal “comms trouble” LED will light and a trouble condition will be displayed on the fascia of the fire control panel. The seven segment display on the panel will show the number of the unit that is disconnected and all LEDs on the status unit that is disconnected will flash.

This page intentionally left blank.

## Appendix A Specifications

This appendix provides electrical and environmental specifications for the HCVR-3 Releasing Fire Control Panel with Releasing.

### Electrical

#### AC Line Connection

Terminals	Description	Voltage
L	AC Line	115 VAC @ 50 / 60Hz (Supervised)
		230 VAC @ 50 / 60Hz (Supervised)
N	AC Neutral	
G 	Earth-Ground	

#### Power Supply

AC Input Fuse	1.6 Amp, 250 VAC, slow-blow, 5 x 20mm
Input (Supervised)	115 or 230 VAC 50/60Hz
Transfer Voltage	115 VAC transfer @ 90 VAC 230 VAC transfer @ 180 VAC

#### System Power-Limitations

Standby and alarm operation of the fire control panel are expressed in volt-amperes VA at the primary of the power supply. Standby and alarm operations measured at the primary of the power supply are determined under no load conditions.

Secondary standby and alarm currents of the power supply are determined under no load conditions and occur during an AC power failure at the primary. Standby-battery operation initiates on the secondary during an AC power failure at the primary of the power supply. The resulting no-load current draw from the fire control panel occurs from standby-battery operation on the secondary.

*All panel loads listed are exclusive of all external loads except EOL devices. "Primary" panel loads assume a fully charged battery. Alarm currents are dependent on the number of zones active, and releasing state.*

**Standby and Alarm Power-Limitations**

The following standby and alarm power limitations are provided below for the HCVR-3 Releasing Fire Control Panel:

<b>Power Source</b>	<b>Standby Operation</b>	<b>Alarm Operation</b>
<b>Power Supply Primary, 115 VAC</b>		125 VA
<b>Power Supply Primary, 230 VAC</b>		126 VA
<b>Current Draw From Battery In Mains Fail Condition</b>	100 mA, 86 mA with internal sounder silenced	250 to 620 mA

**Maximum Current Draw**

The maximum current draw of the HCVR-3 Releasing Fire Control Panel cannot exceed 2.0 A. Outputs of the fire control panel can be loaded with any combination of currents as long as the total current does not exceed 2.0 A.

*All calculations of maximum current draw must include the 620 mA current required to operate the HCVR-3 Releasing Fire Control Panel while in an alarm condition.*

Outputs of the HCVR-3 Releasing Fire Control Panel are listed below:

<b>Terminals</b>	<b>Current Rating</b>
HCVR-3 Releasing Fire Control Panel	620 mA
Exting.	1.0 A
Status Display Unit, Power	500 mA
AUX 24V	500 mA
NAC 1	<i>Reference "Notification Appliance Circuit (NAC)" of this appendix for current ratings.</i>
NAC 2	<i>Reference "Notification Appliance Circuit (NAC)" of this appendix for current ratings.</i>
NAC 3	<i>Reference "Notification Appliance Circuit (NAC)" of this appendix for current ratings.</i>

## Rechargeable Battery Circuit

<b>Standby-Battery Type</b>	12 VDC, 7 AH, sealed lead acid
<b>Standby-Battery Charging</b>	Two standby batteries wired in series
<b>Charge Current</b>	700 mA maximum
<b>Output Current</b>	0 - 2 Amps
<b>Battery Fuse</b>	3.0 A, 250 VAC, slow-blow, (.2 x 0.787401)" ((5 x 20) mm)
<b>Battery Charge Voltage</b>	27.6 VDC current limited at 700 mA maximum
<b>Current Draw From Battery In Mains Fail, Standby, Not in Alarm</b>	100 mA with buzzer sounding
<b>Maximum Current Draw of FACP, In Alarm</b>	620 mA (Current does not include loads from NACs, Solenoid, Status Display Units, Ancillary Boards and Auxiliary equipment)
<b>Maximum Current Draw From Batteries</b>	2 Amps

### Standby-Battery Loads

Standby-batteries of the HCVR-3 Releasing Fire Control Panel are rated for 7 AH of operation. The standby-batteries can provide an operating duration of twenty-four hours followed by five minutes of alarm when the standby current does not exceed 236 mA.

Standby and alarm current of the HCVR-3 Releasing Fire Control Panel can include all or part of the following loads:

<b>Loads</b>	<b>Standby Current</b>	<b>Alarm Current</b>
FACP	100 mA	620 mA
Status Unit	50 mA (per unit)	83 mA average per unit (max) 94 mA peak per unit (max)
Ancillary Board	16 mA (per board)	175 mA per board (max)
NAC Outputs	0 mA (per NAC output)	500 mA (per NAC output)
Releasing Output	0 mA	1000 mA
<b>Total Maximum Current</b>	236 mA	2000 mA

NAC outputs on the HCVR-3 Releasing Fire Control Panel are load dependant and are limited to a maximum current load of 500 mA. The releasing output on the HCVR-3 Releasing Fire Control Panel is load dependant and is limited to a maximum current load of 1000 mA.

Total standby-current of these loads must draw less than 236 mA to maintain continuous standby operation for twenty-four hours followed by five minutes of alarm.

Current loading calculations do not include the combined IDC currents of the HCVR-3 Releasing Fire Control Panel. These combined IDC currents are negligible in comparison to fire control panel, ancillary device and NAC currents of the HCVR-3 Releasing Fire Control Panel and are therefore excluded from the current loading calculation.

### **Ground Trouble Indication**

A ground trouble indication occurs when a minimum of 30K Ohms exists between earth-ground and the following VDC terminals of the fire control panel:

- AUX 24V
- POWER, STATUS UNITS
- NAC 1, NAC 2 and NAC 3
- ZONE 1, ZONE 2, ZONE 3
- MODE SELECT
- MAN RELEASE
- ABORT
- REL. PRES. SWITCH
- EXTING.
- LOW P. SWITCH

### **Field Wiring**

The following specifications identify the range of acceptable wire gages for field wiring, battery and power connections:

<b>Terminal</b>	<b>Wire Range</b>
<b>AUX 24V</b>	14 - 18 AWG
<b>REMOTE CONTROL</b>	<b>No Connection (NC)</b>
<b>DATA - STATUS UNITS</b>	14 - 18 AWG
<b>POWER - STATUS UNITS</b>	14 - 18 AWG
<b>NAC 1, NAC 2</b>	14 - 18 AWG
<b>ZONE 1, ZONE 2, ZONE 3</b>	14 - 18 AWG
<b>2ND SOUNDER</b>	14 - 18 AWG



Terminal	Wire Range
1ST STAGE	14 - 18 AWG
2ND STAGE	14 - 18 AWG
MODE SELECT	14 - 18 AWG
MAN RELEASE	14 - 18 AWG
ABORT	14 - 18 AWG
REL PRES SWITCH	14 - 18 AWG
EXTING.	14 - 18 AWG
LOW PRES. SWITCH	14 - 18 AWG
EXTRACT	14 - 18 AWG
TROUBLE RELAY	14 - 18 AWG
LOCAL FIRE	14 - 18 AWG
FIRE RELAY	14 - 18 AWG

**Battery and Line Connections**

Designation	Terminal	Wire Range	Description
<b>Battery Connection</b>	+ Red lead		Positive connection for the Standby-batteries
	- Black lead		Negative connection for the Standby-batteries
<b>AC Power</b>	L	14 AWG	Line connection
	N	14 AWG	Neutral connection
	E	14 AWG	Ground connection

*Battery leads are provided in the cabinet for recharging the standby-batteries. One end of the battery leads are permanently connected to the power supply of the HCVR-3 Releasing Fire Control Panel. The opposite end of the battery leads connect to terminals of the standby-batteries.*

**Field Terminal Capacity**

Field terminal capacity: 14 to 22 AWG solid or stranded wire

**Initiating Device Circuit (IDC) Ratings**

Parameter	Rating
Maximum Operating Voltage	21.6 VDC
Maximum Short Circuit Current	65 mA
Maximum Line Impedance	20.3 Ohms
Maximum Number of Detectors on Zones 1, 2 and 3	<i>Reference Appendix B, Equipment List, Detectors</i>
Detector Compatibility Identifier on Zones 1, 2 and 3	<i>Reference Appendix B, Equipment List, Detectors</i>
Detector Installation Limits on Zones 1, 2 and 3	<i>Reference Appendix B, Equipment List, Detectors</i>

*The maximum line impedance shown in the table above represents all initiating circuit types on detection zones of the HCVR-3 Releasing Fire Control Panel.*

**Notification Appliance Circuit (NAC)**

Connection	Rating
NAC 1 ( + ) NAC 1 ( - )	Special Application: 18 to 28 VDC @ 500 mA continuous Regulated: 18 to 28 VDC @ 50 mA continuous Fused: Electronic 1.1 A Supervision: Voltage reversing DC Short Circuit Threshold: 130 Ohms +/- 20% Maximum line-voltage-drop: 2 VDC
NAC 2 ( + ) NAC 2 ( - )	Special Application: 18 to 28 VDC @ 500 mA continuous Regulated: 18 to 28 VDC @ 50 mA continuous Fused: Electronic 1.1 A Supervision: Voltage reversing DC Short Circuit Threshold: 130 Ohms +/- 20% Maximum line-voltage-drop: 2 VDC

<b>Connection</b>	<b>Rating</b>
NAC 3 ( + ) NAC 3 ( - )	Releasing Output Only Special Application: 18 to 28 VDC @ 500 mA pulsed and continuous Regulated: 18 to 28 VDC @ 50 mA pulsed and continuous Fused: Electronic 1.1 A Supervision: Voltage reversing DC Short Circuit Threshold: 130 Ohms +/- 20% Maximum line-voltage-drop: 2 VDC

## Releasing Device Circuit

### Releasing Inputs

<b>Monitored Input EOL</b>	Monitored Input EOL: 6.8K Ohm, 0400-03140 +/- 5% resistor supplied in terminals, activation impedance: 470 Ohms
<b>Mode Select</b>	Monitored Input EOL: 6.8K Ohm, 0400-03140 +/- 5% resistor supplied in terminals, activation impedance: 470 Ohms
<b>Manual Release</b>	Monitored Input EOL: 6.8K Ohm, 0400-03140 +/- 5% resistor supplied in terminals, activation impedance: 470 Ohms
<b>Abort</b>	Monitored Input EOL: 6.8K Ohm, 0400-03140 +/- 5% resistor supplied in terminals, activation impedance: 470 Ohms
<b>Rel. Press. Switch</b>	Monitored Input EOL: 6.8K Ohm, 0400-03140 +/- 5% resistor supplied in terminals, activation impedance: 470 Ohms
<b>Low Press. Switch</b>	Monitored Input EOL: 6.8K Ohm, 0400-03140 +/- 5% resistor supplied in terminals, activation impedance: 470 Ohms

**Releasing Outputs**

<b>Exting.</b>	Releasing output: 18 to 28 VDC, with 1.0 Amp maximum load for 5 minutes and voltage reversing DC. Maximum line-voltage-drop: 2.4 VDC Fused at 1.6 Amps
<b>Extract</b>	Power Factor: 1.0 Relay Function: Common EXTRACT (NO) and (C): 30 VDC @ 1A Amp maximum, volt free change over contact
<b>Extinguishant Output End of Line</b>	1N4004 diode supplied in terminals
<b>Extinguishant Output Delay</b>	Adjustable 0 to 60 seconds (+/- 10%) in 5 second steps
<b>Extinguishant Duration</b>	Adjustable 60 to 300 seconds (+/- 10%) in 5 second steps
<b>Short Circuit Threshold</b>	Adjustable

**Relay Ratings**

<b>Terminals</b>	<b>Ratings</b>
<b>TROUBLE RELAY (NC), (C) and (NO)</b>	Power Factor: 1.0 Relay Function: Common 30 VDC @ 1A maximum, volt free change over contact
<b>LOCAL FIRE (NC), (C) and (NO)</b>	Power Factor: 1.0 Relay Function: Common 30 VDC @ 1A maximum, volt free change over contact
<b>FIRE RELAY (NC), (C) and (NO)</b>	Power Factor: 1.0 Relay Function: Common 30 VDC @ 1A maximum, volt free change over contact

Terminals	Ratings
<b>1st STAGE RELAY (NC), (C) and (NO)</b>	Power Factor: 1.0 Relay Function: Common 30 VDC @ 1A maximum, volt free change over contact
<b>2nd STAGE RELAY (NC), (C) and (NO)</b>	Power Factor: 1.0 Relay Function: Common 30 VDC @ 1A maximum, volt free change over contact
<b>EXTRACT (NO) and (C)</b>	Power Factor: 1.0 Relay Function: Common 30 VDC @ 1A maximum, volt free change over contact

### AUX 24V

Terminal	Rating
<b>AUX 24V (+ / R0V)</b>	18 - 28 VDC Special Application Output, 500 mA maximum

### Power Output Circuits

The HCVR-3 Releasing Fire Control Panel provides power output circuits on NAC 1, NAC 2, NAC 3, AUX 24V, STATUS DISPLAY UNITS, POWER and the EXTING terminals.

*Reference Section 3, Installation for figures of the Notification Appliance Circuits and Status Units.*

### Remote Control Inputs

Remote Control Inputs are unused on the terminal-strip of the fire control panel:

Terminal	Function
<b>ROV</b>	No Connection (NC)
<b>SIL</b>	NC
<b>AL</b>	NC
<b>FLT</b>	NC
<b>RST</b>	NC

## Status Unit Terminals

### POWER Terminals

<b>Maximum Output Rating</b>	18 to 28 VDC, 1.1 A electronic fuse, 500 mA maximum load
<b>Connector Terminals</b>	Terminals accept 14 to 22 AWG wire.
<b>Maximum Number of Units</b>	Load dependant, 500 mA maximum in alarm

### DATA Terminals

<b>RS485 Serial Bus</b>	RS485 Serial Bus, Two-wire RS485 Maximum line impedance: 120 Ohms
<b>Connector Terminals</b>	Terminals accept 14 to 18 AWG wire.
<b>Maximum Number of Units</b>	7 Status Units, 7 Ancillary Boards <i>A separate power source must be used if the total-load-current at the STATUS DISPLAY UNIT, POWER terminals exceeds the 500 mA maximum of this output.</i>

## Cabling

<b>Grounding Conductor</b>	Install ground conductors with 14 AWG cabling to support branch circuits of the HCVR-3 releasing Fire Control Panel.
<b>Branch Circuits</b>	Protect branch circuits from the AC power source with a 15 Amp fuse.
<b>Material</b>	All field wiring should be installed using fire rated cables according to the NFPA.
<b>Cross Sectional Size</b>	The cross sectional size of Zone cabling should be determined based on length and the number of devices in use. Connect Zone cabling using a minimum of 1 mm cross sectional area.

## Supplementary Devices

### Status Display Unit - HCVR-SDU

<b>Power Supply</b>	21 to 28 VDC
<b>Maximum Current Draw</b>	83 mA (average per unit) 94 mA (peak per unit)
<b>Maximum Number Of Status Units</b>	7
<b>Standby Current</b>	50 mA (35 mA with local NAC silenced)
<b>Terminal Capacity</b>	18 to 22 AWG wire
<b>Data Connection</b>	Two wire RS485 connection Maximum line impedance: 120 Ohms
<b>Supervised EOL resistor</b>	6.8K Ohm, 0400-03140
<b>Mode Input</b>	No Connect (NC) terminal

### Ancillary Board - HCVR-AB

<b>Power Supply</b>	21 to 28 VDC
<b>Maximum Current Draw</b>	175 mA
<b>Maximum Number Of Ancillary Boards</b>	7
<b>Standby Current</b>	16 mA
<b>Terminal Capacity</b>	Terminals accept 14 to 22 AWG wire
<b>Data Connection</b>	Two wire RS485 connection Maximum line impedance: 120 Ohms
<b>Communication</b>	RS485 data
<b>Power Factor</b>	1.0
<b>Relay Function</b>	Common
<b>Relay Contact</b>	30 VDC @ 1A maximum, volt free change over contact
<b>Power Fault (PF)</b>	No Connect (NC) terminal

## Operating Environment

<b>Low Temperature</b>	23° F ( - 5° C )
<b>High Temperature</b>	104° F ( + 40° C )
<b>Relative Humidity</b>	This device functions in an atmosphere of relative humidity up to 93 percent, non-condensing.

## Physical Specifications

<b>Dimensions</b>	15.2" (385 mm) H X 12.2" (310 mm) W X 3.5" (90 mm) D
<b>Mounting</b>	Maximum Screw Diameter: 0.2" (5 mm) screws

This fire control panel is designed for indoor use only.



## Appendix B Equipment List

This appendix describes models of the HCVR-3 Releasing Fire Control Panel, supporting equipment and devices.

### HCVR-3 Releasing Fire Control Panels

The following models are provided for the HCVR-3 Releasing Fire Control Panel:

Models	Features	Color
HCVR-3-R (115V)	HCVR-3 Extinguishant Panel - 115 VAC	Red
HCVR-3-R (230V)	HCVR-3 Extinguishant Panel - 230 VAC	Red
HCVR-3-C (115V)	HCVR-3 Extinguishant Panel - 115 VAC	Charcoal
HCVR-3-C (230V)	HCVR-3 Extinguishant Panel - 230 VAC	Charcoal

### Detectors

Detector models from Hochiki can be mixed between separate zones of the fire control panel.

**Compatibility Identifier, HCVR-3 Releasing Fire Control Panel: AXT0110**

**Compatibility Identifier, Detectors Hochiki: AXT0110**

Detector models from Hochiki are compatible for use on the Initiating Device Circuits of the HCVR-3 Releasing Fire Control Panel.

### Hochiki

Detector Models	Base Models	Maximum Number of Devices
DCD-135	NS4-220 NS6-220	20
DCD-190	NS4-220 NS6-220	20
SIJ24	NS4-220 NS6-220	20
SLR-24H	NS4-220 NS6-220	20
SLR835	NS4-220 NS6-220	20

**Hochiki America Corporation**  
**HCVR-3 Series - Conventional Fire Alarm Releasing System**  
**Installation and Operation Manual, HA-06-294, Version V02.10**

Detector Models	Base Models	Maximum Number of Devices
SLR-835B-2	N/A	20
SLR-835BH-2	N/A	20
SLR-835H	NS4-220 NS6-220	20
SLV-24V/-24/-24N	NS4-220 NS6-220	20

## Supporting Equipment and Devices

The following models are authorized to operate on the STATUS DISPLAY UNITS terminals and the AUX 24V special application terminals of the HCVR-3 Releasing Fire Control Panel:

Models	Features	Color
HCVR-SDU-6S-R	6 Lamp Status Display Unit Surface Mount	Red
HCVR-SDU-6S-C	6 Lamp Status Display Unit Surface Mount	Charcoal
HCVR-SDU-6F-R	6 Lamp Status Display Unit Flush Mount	Red
HCVR-SDU-6F-C	6 Lamp Status Display Unit Flush Mount	Charcoal
HCVR-SDU-6SM-R	6 Lamp Status Display Unit Surface Mount w/ Mode select switch	Red
HCVR-SDU-6SM-C	6 Lamp Status Display Unit Surface Mount w/ Mode select switch	Charcoal
HCVR-SDU-6FM-R	6 Lamp Status Display Unit Flush Mount w/ Mode select switch	Red
HCVR-SDU-6FM-C	6 Lamp Status Display Flush Mount w/ Mode select switch	Charcoal
HCVR-AB	HCVR-3 Ancillary Board	N/A
HCVR-ABE-R	HCVR-3 Ancillary Board Enclosure	Red
HCVR-ABE-C	HCVR-3 Ancillary Board Enclosure	Charcoal
HCVR-AS-R	HCVR-AS Extinguishant Abort Switch - Surface Mount	Red
HCVR-AS-C	HCVR-AS Extinguishant Abort Switch - Surface Mount	Charcoal
0400-01046	10K Ohm Resistor ( 1 ): End of Line (EOL) resistor	N/A
0400-01046	10K Ohm Resistor (1): Used as End of Line (EOL) resistor	N/A

Models	Features	Color
0400-03140	6.8K Ohm Resistor (1): Used as End of Line (EOL) resistor	N/A
0400-03150	470 Ohm Resistor (1): Used as trigger resistor	N/A
0400-03160	270 Ohm Resistor (1): Used as series resistor	N/A
HCVR-3-ENC-BC-R	Enclosure Back Box	Red
HCVR-3-ENC-BC-C	Enclosure Back Box	Charcoal
HCVR-3-ENC-F-R	Enclosure Fascia	Red
HCVR-3-ENC-F-C	Enclosure Fascia	Charcoal
HCVR-3-ENC-DO-R	Enclosure Box Lid	Red
HCVR-3-ENC-DO-R	Enclosure Box Lid - Gray	Charcoal

## Replacement Parts

The following replacement parts are provided for the HCVR-3 Releasing Fire Control Panel:

Models	Description
1700-11920	HCVR-3 Releasing Fire Control Panel - Installation and Operation Manual
1700-11930	Operating Instructions
1700-05960	UL Compliance Label
1700-05952	Wiring Diagram
0400-01046	10K Ohm Resistor (1): Used as End of Line (EOL) resistor
0400-03140	6.8K Ohm Resistor (1): Used as End of Line (EOL) resistor
0400-03150	470 Ohm Resistor (1): Used as trigger resistor
0400-03160	270 Ohm Resistor (1): Used as series resistor
0400-03170	1N504-G Diode (1): Used as End of Line (EOL) diode
N/A	UL Listed 12 Volt, 7 AH, two per cabinet

## Notification Appliances

Outputs of NAC 1 and NAC 2 of the HCVR-3 Releasing Fire Control Panel operate in a special application mode when conforming to specific levels of continuous DC. Outputs meet these requirements when NAC currents do not exceed 500 mA on NAC 1 or NAC 2 with the combined currents not to exceed 1.0 A.

The HCVR-3 Releasing Fire Control Panel supports special application outputs of NAC 1 and NAC 2 when operating:

- Amseco NAC devices with synchronization modules
- Gentex NAC devices with synchronization modules
- System Sensor NAC devices with synchronization modules
- Wheelock NAC devices with synchronization modules

## Synchronization

NAC channels 1 and 2 of the HCVR-3 Releasing Fire Control Panel provide single and dual circuit synchronization. Single circuit synchronization provides a synchronized output on one channel of two NAC channels. Dual circuit synchronization provides a synchronized output on NAC 1 and NAC 2.

The HCVR-3 Releasing Fire Control Panel provides synchronization for the outputs of NAC 1 and NAC 2 when operating external synchronization devices and NAC devices from Amseco, Gentex, System Sensor or Wheelock.

## Synchronization Modules

Synchronize the special application output of NAC 1 and NAC 2 using the UL listed and compatible synchronization modules described in the table below:

Manufacturer	Manufacturer Sync Module	Hochiki Sync Module	Manufacturer and Hochiki NAC Device
<b>Amseco</b>	SMD10-3A		***
<b>Gentex</b>	AVSM-R (Red) AVSM-W (White)	HAVSM-R (Red) HAVSM-W (White)	***
<b>System Sensor</b>	MDL (Red) MDLW (White)		***
<b>Wheelock</b>	SM-24-R DSM-24-R		***

Connect one 10K EOL resistor, 0400-01046 to the output of each Synchronization Module.

\*\*\* All NAC devices that are compatible with the synchronization modules above are compatible for use with the HCVR-3 Releasing Fire Control Panel.

### Amseco Compatible NAC Devices

The HCVR-3 Releasing Fire Control Panel accepts compatible Amseco NAC devices for use on the special application outputs of NAC 1 and NAC 2. The number of compatible devices that NAC 1 and NAC 2 can each safely operate is limited by a 500 mA current threshold. Installers must limit the population of compatible devices in each NAC circuit by this 500 mA threshold.

As with any circuit, a circuit design is limited by the power source and device-loads connected to it. A combination of device-loads can be safely installed in a circuit when the circuit is operated within the constraints of the power source threshold. There are no exclusions for the amount of device-loads that can be safely installed in the circuit as long as the maximum current load is below the output current available from the power source.

The HCVR-3 Releasing Fire Control Panel can also safely operate combinations of device-loads on NAC 1 and NAC 2. These device-loads can include combinations such as strobes, horns, strobe/chimes, strobe/horns and speaker strobes. The sum of this device-load combination is limited by the 500 mA available from each NAC output. Hochiki recommends designing and installing combinations of NAC circuits based on this “device-load” versus “current-available” understanding.

*Reference manufacturer data sheets for individual device loads and then total the loads to determine if the sum exceeds the 500 mA threshold of each NAC output.*

### UL Listing Requirement

All control panel designs restrict the number of NAC devices installed in circuits based on the rated current threshold. Some control panel designs further restrict the number of NAC devices installed in circuits based on device synchronization in addition to the rated current threshold. These control panel designs can reduce the population of NAC devices below the number of devices that would be considered for the rated current threshold.

NAC outputs of the HCVR-2 Releasing Fire Control Panel are not limited by conditions other than the maximum rated current threshold. NAC outputs of the HCVR-3 Releasing Fire Control Panel can operate combinations of Hochiki authorized NAC devices as long as the circuit load does not exceed 500 mA.

The following statement is necessary for UL qualification and excludes device-loading combinations that are common in most FACP installations:

**NAC 1 and NAC 2 of the HCVR-3 Releasing Fire Control Panel can each operate a maximum of seven Amseco SL-1224 strobes when configured for 15cd outputs and synchronized with an Amseco SMD10-3A synchronization module.**

The following series of Amseco NAC devices are compatible for use on the special application outputs of NAC 1 and NAC 2 when connecting Amseco synchronization modules and operating each NAC output below 500 mA:

Name of Series	Environment	Model Series	Description	Mount
Select-A-Strobe/Chime	Indoor	CM24C	Chime	Ceiling
Select-A-Strobe/Chime	Indoor	SCM24C	Chime Strobe	Ceiling
Select-A-Horn	Indoor/Outdoor	H-1224	Horn	Wall

### Hochiki America Corporation

**HCVR-3 Series - Conventional Fire Alarm Releasing System  
Installation and Operation Manual, HA-06-294, Version V02.10**

Name of Series	Environment	Model Series	Description	Mount
Select-A-Strobe/Horn	Indoor	SH-1224	Horn Strobe	Wall
Select-A-Strobe/Horn	Outdoor	SH-1224WP	Horn Strobe	Wall
Select-A-Strobe/Horn	Indoor	SH24C-177	Horn Strobe	Wall/Ceiling
Select-A-Strobe/Horn	Indoor	SH24C-3075110	Horn Strobe	Wall/Ceiling
Speaker/Strobe Square	Indoor/Outdoor	SSS-2	Speaker Strobe	Wall
Speaker/Strobe Square	Indoor/Outdoor	SSS-8	Speaker Strobe	Wall
Speaker/Strobe Round	Indoor/Outdoor	SSR-2	Speaker Strobe	Wall/Ceiling
Speaker/Strobe Round	Indoor/Outdoor	SSR-8	Speaker Strobe	Wall/Ceiling
Speaker/Strobe Round	Indoor	SSC-2	Speaker Strobe	Wall/Ceiling
Speaker/Strobe Round	Indoor	SSC-8	Speaker Strobe	Wall/Ceiling
Select-A-Strobe	Indoor	SL-1224	Strobe	Wall
Select-A-Strobe	Indoor/Outdoor	SL-1224-WP	Strobe	Wall
Select-A-Strobe	Indoor	SL24C-3075110	Strobe	Wall/Ceiling
Select-A-Strobe	Indoor	SL24C-177	Strobe	Wall/Ceiling
Bell/Select-A-Strobe	Indoor	SB24	Bell Strobe	Wall/Ceiling
Select-A-Strobe/Chime	Indoor	SCM24W-153075	Chime Strobe	Wall
Select-A-Strobe/Chime	Indoor	SCM24W-75110	Chime Strobe	Wall
Select-A-Horn	Indoor	H24W	Horn	Wall/Ceiling
Select-A-Strobe/Horn	Indoor	SH24W-1530	Horn Strobe	Wall
Select-A-Strobe/Horn	Indoor	SH24W-75110	Horn Strobe	Wall
Indoor/Outdoor Horn/ Strobe	Indoor/Outdoor	SHB24-75	Horn Strobe	Wall
Speaker/Strobe	Indoor	SSC25-177	Speaker Strobe	Wall/Ceiling
Select-A-Strobe/Speaker	Indoor	SSC25-3075110	Speaker Strobe	Wall/Ceiling

Name of Series	Environment	Model Series	Description	Mount
Speaker/Strobe	Indoor	SSC70-177	Speaker Strobe	Wall/Ceiling
Select-A-Strobe/Speaker	Indoor	SSC70-3075110	Speaker Strobe	Wall/Ceiling
Select-A-Strobe/Speaker	Indoor	SFH45-153075	Speaker Strobe	Wall/Ceiling
Select-A-Strobe/Speaker	Indoor	SFH47-75110	Speaker Strobe	Wall/Ceiling
Select-A-Strobe	Indoor	SL24W-1530	Strobe	Wall
Select-A-Strobe	Indoor	SL24W-75110	Strobe	Wall
Indoor/Outdoor Strobe	Indoor/Outdoor	SLB24-75	Strobe	Wall
Select-A-Strobe	Indoor/Outdoor	SB24	Strobe	Wall/Ceiling
Select-A-Strobe/Horn	Indoor	SH24W-153075	Horn Strobe	Wall
Select-A-Strobe	Indoor	SL24W-153075	Strobe	Wall
Select-A-Strobe	Indoor	ASH-2475110R	Horn Strobe	Wall
Select-A-Strobe	Indoor	RSB24-153075	Strobe	Wall/Ceiling
Select-A-Strobe	Indoor	RSD24-153075	Strobe	Wall/Ceiling
Select-A-Strobe	Indoor	RSD24-75110	Strobe	Wall/Ceiling
Select-A-Strobe	Indoor	SA24 SERIES	Strobe	Wall
Select-A-Strobe	Indoor	SAD24-153075	Strobe	Wall/Ceiling
Select-A-Strobe	Indoor	SAD24-75110	Strobe	Wall

### Gentex Compatible NAC Devices

The HCVR-3 Releasing Fire Control Panel accepts compatible Gentex NAC devices for use on the special application outputs of NAC 1 and NAC 2. The number of compatible devices that NAC 1 and NAC 2 can each safely operate is limited by a 500 mA current threshold. Installers must limit the population of compatible devices in each NAC circuit by this 500 mA threshold.

As with any circuit, a circuit design is limited by the power source and device-loads connected to it. A combination of device-loads can be safely installed in a circuit when the circuit is operated within the constraints of the power source threshold. There are no exclusions for the amount of device-loads that can be safely installed in the circuit as long as the maximum current load is below the output current available from the power source.

The HCVR-3 Releasing Fire Control Panel can also safely operate combinations of device-loads on NAC 1 and NAC 2. These device-loads can include combinations such as strobes, horns, strobe/chimes, strobe/horns and speaker strobes. The sum of this device-load combination is limited by the 500 mA available from each NAC output. Hochiki recommends designing and installing combinations of NAC circuits based on this “device-load” versus

“current-available” understanding.

*Reference manufacturer data sheets for individual device loads and then total the loads to determine if the sum exceeds the 500 mA threshold of each NAC output.*

**UL Listing Requirement**

All control panel designs restrict the number of NAC devices installed in circuits based on the rated current threshold. Some control panel designs further restrict the number of NAC devices installed in circuits based on device synchronization in addition to the rated current threshold. These control panel designs can reduce the population of NAC devices below the number of devices that would be considered for the rated current threshold.

NAC outputs of the HCVR-3 Releasing Fire Control Panel are not limited by conditions other than the maximum rated current threshold. NAC outputs of the HCVR-3 Releasing Fire Control Panel can operate combinations of Hochiki authorized NAC devices as long as the circuit load does not exceed 500 mA.

The following statement is necessary for UL qualification and excludes device-loading combinations that are common in most FACP installations:

**NAC 1 and NAC 2 of the HCVR-3 Releasing Fire Control Panel can each operate a maximum of six Gentex GES3-24 strobes when configured for 15cd outputs and synchronized with a Gentex AVSM synchronization module.**

The following series of Gentex NAC devices are compatible for use on the special application outputs of NAC 1 and NAC 2 when connecting Gentex synchronization modules and operating each NAC output below 500 mA:

<b>Name of Series</b>	<b>Environment</b>	<b>Model Series</b>	<b>Description</b>	<b>Mount</b>
<b>WSSPK Series</b>	Outdoor	WSSPK24-15/75	Speaker Strobe	Wall
<b>SSPK24WLP Series</b>	Indoor	SSPK24WLP	Speaker Strobe	Wall
<b>SSPKCLP Series</b>	Indoor	SSPK24CLP	Speaker Strobe	Ceiling
<b>Commander4 Series</b>	Indoor	GCC24	Horn Strobe	Ceiling
<b>Commander4 Series</b>	Indoor	GCS24	Strobe	Ceiling
<b>Commander3 Series</b>	Indoor	GEC3-24	Horn Strobe	Wall
<b>Commander3 Series</b>	Indoor	GES3-24	Strobe	Wall
<b>Commander3 Series</b>	Indoor	GEH24	Horn	Wall



Name of Series	Environment	Model Series	Description	Mount
<b>Commander2 Series</b>	Indoor	GEC24	Horn Strobe	Wall
<b>Commander2 Series</b>	Indoor	GES24	Strobe	Wall
<b>Commander2 Series</b>	Indoor	GEH24	Horn	Wall
<b>Outdoor Commander Series</b>	Outdoor	WGEC24	Horn Strobe	Wall
<b>Outdoor Commander Series</b>	Outdoor	WGES24	Strobe	Wall
<b>Outdoor Commander Series</b>	Outdoor	GEH24	Horn	Wall
<b>GX91/GX93 Series</b>	Indoor	GX93	Mini Horn	Wall

#### Hochiki America Multiple-Listed Gentex Models

The following Hochiki America NAC models are multiple-listed with Gentex and are compatible for use on the special application outputs of NAC 1 and 2 when operating under the constraints described in “Gentex Compatible NAC Devices” of this section:

Hochiki Models	Gentex Models	Gentex Part Numbers	Description
<b>HEH24-WR</b>	GEH24-WR	904-1205-002	Horn, Wall Red (GEH)
<b>HEH-24-WW</b>	GEH24-WW	904-1207-002	Horn, Wall White (GEH)
<b>HES3-24WR</b>	GES3-24WR	904-1321-002	Strobe, Wall Red Multi Candela (GES3)
<b>HES3-24WW</b>	GES3-24WW	904-1319-002	Strobe, Wall White Multi Candela (GES3)
<b>HEC3-24WR</b>	GEC3-24WR	904-1317-002	Horn/Strobe, Wall Red Multi Candela (GEC3)
<b>HEC3-24WR</b>	GEC3-24WW	904-1315-002	Horn/Strobe, Wall White Multi Candela (GEC3)
<b>HCS24CR</b>	GCS24CR	904-1213-002	Strobe, Ceiling Red Multi Candela (GCS)
<b>HSC24CW</b>	GCS24CW	904-1215-002	Strobe, Ceiling White Multi Candela (GCS)

Hochiki Models	Gentex Models	Gentex Part Numbers	Description
<b>HCC24CR</b>	GCC24CR	904-1209-002	Horn/Strobe, Ceiling Red Multi Candela (GCC)
<b>HCC24CW</b>	GCC24CW	904-1211-002	Horn/Strobe, Ceiling White Multi Candela (GCC)
<b>WHEC24-75WR</b>	WGEC24-75WR	904-1217-002	Weatherproof Horn/Strobe, Red

### System Sensor Compatible NAC Devices

The HCVR-3 Releasing Fire Control Panel accepts compatible System Sensor NAC devices for use on the special application outputs of NAC 1 and NAC 2. The number of compatible devices that NAC 1 and NAC 2 can each safely operate is limited by a 500 mA current threshold. Installers must limit the population of compatible devices in each NAC circuit by this 500 mA threshold.

As with any circuit, a circuit design is limited by the power source and device-loads connected to it. A combination of device-loads can be safely installed in a circuit when the circuit is operated within the constraints of the power source threshold. There are no exclusions for the amount of device-loads that can be safely installed in the circuit as long as the maximum current load is below the output current available from the power source.

The HCVR-3 Releasing Fire Control Panel can also safely operate combinations of device-loads on NAC 1 and NAC 2. These device-loads can include combinations such as strobes, horns, strobe/chimes, strobe/horns and speaker strobes. The sum of this device-load combination is limited by the 500 mA available from each NAC output. Hochiki recommends designing and installing combinations of NAC circuits based on this “device-load” versus “current-available” understanding.

*Reference manufacturer data sheets for individual device loads and then total the loads to determine if the sum exceeds the 500 mA threshold of each NAC output.*

### UL Listing Requirement

All control panel designs restrict the number of NAC devices installed in circuits based on the rated current threshold. Some control panel designs further restrict the number of NAC devices installed in circuits based on device synchronization in addition to the rated current threshold. These control panel designs can reduce the population of NAC devices below the number of devices that would be considered for the rated current threshold.

NAC outputs of the HCVR-3 Releasing Fire Control Panel are not limited by conditions other than the maximum rated current threshold. NAC outputs of the HCVR-3 Releasing Fire Control Panel can operate combinations of Hochiki authorized NAC devices as long as the circuit load does not exceed 500 mA.

The following statement is necessary for UL qualification and excludes device-loading combinations that are common in most FACP installations:

**NAC 1 and NAC 2 of the HCVR-3 Releasing Fire Control Panel can each operate a maximum of eight System Sensor S1224MC strobes when configured for 15cd outputs and synchronized with a System Sensor MDL synchronization module.**

The following series of System Sensor NAC devices are compatible for use on the special application outputs of NAC 1 and NAC 2 when connecting System Sensor synchronization modules and operating each NAC output below 500 mA:

<b>Name of Series</b>	<b>Environment</b>	<b>Model Series</b>	<b>Description</b>	<b>Mount</b>
<b>SpectrAlert Advance</b>	Indoor	SPS	Speaker Strobe	Wall
<b>SpectrAlert Advance</b>	Indoor	SPSC	Speaker Strobe	Ceiling
<b>SpectrAlert Advance</b>	Outdoor	SPS (K)	Speaker Strobe	Wall
<b>SpectrAlert Advance</b>	Outdoor	SPSC (K)	Speaker Strobe	Ceiling
<b>SpectrAlert Advance</b>	Indoor	P2	Horn Strobe, 2-Wire	Wall
<b>SpectrAlert Advance</b>	Indoor	P4	Horn Strobe, 4-Wire	Wall
<b>SpectrAlert Advance</b>	Indoor	S	Strobe	Wall
<b>SpectrAlert Advance</b>	Indoor	PC2	Horn Strobe, 2-Wire	Ceiling
<b>SpectrAlert Advance</b>	Indoor	PC4	Horn Strobe, 4-Wire	Ceiling
<b>SpectrAlert Advance</b>	Indoor	SC	Strobe	Ceiling
<b>SpectrAlert Advance</b>	Indoor	H	Horn	Wall/Ceiling
<b>SpectrAlert Advance</b>	Outdoor	P2 (K)	Horn Strobe, 2-Wire	Wall
<b>SpectrAlert Advance</b>	Outdoor	P4 (K)	Horn Strobe, 4-Wire	Wall
<b>SpectrAlert Advance</b>	Outdoor	S (K)	Strobe	Wall
<b>SpectrAlert Advance</b>	Outdoor	PC2 (K)	Horn Strobe, 2-Wire	Ceiling

Name of Series	Environment	Model Series	Description	Mount
<b>SpectrAlert Advance</b>	Outdoor	PC4 (K)	Horn Strobe, 4-Wire	Ceiling
<b>SpectrAlert Advance</b>	Outdoor	SC (K)	Strobe	Ceiling
<b>SpectrAlert Advance</b>	Outdoor	H (K)	Horn	Wall/Ceiling
<b>SpectrAlert Advance</b>	Indoor	CH	Chime	Wall/Ceiling
<b>SpectrAlert Advance</b>	Indoor	CHS	Chime Strobe	Wall
<b>SpectrAlert</b>	Indoor	CH24MC	Chime Strobe	Wall
<b>SpectrAlert</b>	Indoor	CH1224	Chime	Wall/Ceiling
<b>SpectrAlert</b>	Indoor	SP2x1224MC	Speaker Strobe	Wall
<b>SpectrAlert</b>	Indoor	SP3x1224MC	Speaker Strobe	Wall
<b>SpectrAlert</b>	Outdoor	SP2R1224MCK	Speaker Strobe	Wall
<b>SpectrAlert</b>		S1224MC	Strobe	Wall
<b>SpectrAlert</b>		P1224MC	Horn Strobe, 4-Wire	Wall
<b>SpectrAlert</b>		H12/24	Horn	Wall/Ceiling

### Cooper/Wheelock Compatible NAC Devices

The HCVR-3 Releasing Fire Control Panel accepts compatible Cooper/Wheelock NAC devices for use on the special application outputs of NAC 1 and NAC 2. The number of compatible devices that NAC 1 and NAC 2 can each safely operate is limited by a 500 mA current threshold. Installers must limit the population of compatible devices in each NAC circuit by this 500 mA threshold.

As with any circuit, a circuit design is limited by the power source and device-loads connected to it. A combination of device-loads can be safely installed in a circuit when the circuit is operated within the constraints of the power source threshold. There are no exclusions for the amount of device-loads that can be safely installed in the circuit as long as the maximum current load is below the output current available from the power source.

The HCVR-3 Releasing Fire Control Panel can also safely operate combinations of device-loads on NAC 1 and NAC 2. These device-loads can include combinations such as strobes, horns, strobe/chimes, strobe/horns and speaker strobes. The sum of this device-load combination is limited by the 500 mA available from each NAC output. Hochiki recommends designing and installing combinations of NAC circuits based on this “device-load” versus “current-available” understanding.

*Reference manufacturer data sheets for individual device loads and then total the loads to determine if the sum exceeds the 500 mA threshold of each NAC output.*

### Hochiki America Corporation

**HCVR-3 Series - Conventional Fire Alarm Releasing System  
Installation and Operation Manual, HA-06-294, Version V02.10**

**UL Listing Requirement**

All control panel designs restrict the number of NAC devices installed in circuits based on the rated current threshold. Some control panel designs further restrict the number of NAC devices installed in circuits based on device synchronization in addition to the rated current threshold. These control panel designs can reduce the population of NAC devices below the number of devices that would be considered for the rated current threshold.

NAC outputs of the HCVR-3 Releasing Fire Control Panel are not limited by conditions other than the maximum rated current threshold. NAC outputs of the HCVR-3 Releasing Fire Control Panel can operate combinations of Hochiki authorized NAC devices as long as the circuit load does not exceed 500 mA.

The following statement is necessary for UL qualification and excludes device-loading combinations that are common in most FACP installations:

**NAC 1 and NAC 2 of the HCVR-3 Releasing Fire Control Panel can each operate a maximum of eight Cooper/ Wheelock RSS-24MCW strobes when configured for 15cd outputs and synchronized with a Cooper/ Wheelock SM-24 synchronization module.**

The following series of Cooper/ Wheelock NAC devices are compatible for use on the special application outputs of NAC 1 and NAC 2 when connecting Cooper/Wheelock synchronization modules and operating each NAC output below 500 mA:

<b>Model Number Series</b>	<b>Description</b>
<b>AMT-12/24</b>	Multitone - 3 inputs
<b>AMT-241575, AMT-24MCW</b>	Multitone Strobe - 1575cd or 15,30,75,110 cd, wall
<b>AMT-241575</b>	Multitone Strobe (NYC) - 1575 cd, wall
<b>AMT-12/24 Audible Only</b>	Multitone Audible only
<b>AS-121575, AS-241575</b>	Audible Strobe - 1575 cd, wall
<b>AS-24MCW</b>	Audible Strobe - 15,30,75,110 cd, wall
<b>AS-24MCC</b>	Audible Strobe - 15,30,75,95 cd, ceiling
<b>AS-24MCWH</b>	Audible Strobe - 135,185 cd, wall
<b>AS-24MCCH</b>	Audible Strobe - 115,177 cd, ceiling
<b>AH-12, AH-24</b>	Audible
<b>ASWP-2475</b>	Audible Strobe - 180 cd, weatherproof
<b>AHWP</b>	Audible - outdoor

**Hochiki America Corporation  
HCVR-3 Series - Conventional Fire Alarm Releasing System  
Installation and Operation Manual, HA-06-294, Version V02.10**

<b>Model Number Series</b>	<b>Description</b>
CH70, CH90	Chime
CH70-241575	Chime - 1575 cd, wall
CH70-24MCW	Chime - 15,30,75,110 cd, wall
CH90-24MCC	Chime - 15,30,75,95 cd, ceiling
CH70-MCWH	Chime - 135,185 cd, wall
CH90-MCCH	Chime - 115,177 cd, ceiling
E50-241575W	Speaker Strobe-wall
E50-MCW	Speaker Strobe - 15,30,75,110 cd, wall
E50-MCWH	Speaker Strobe - 135,185 cd, wall
E60-24MCC	Speaker Strobe 15,30,75,95 cd, ceiling
E60-MCCH	Speaker Strobe 115/177 cd, ceiling
E70A, E70B, E90A, E90B	Speaker Strobe - amber or blue lens
E70-241575	Speaker Strobe - 1575 cd, wall
E70-24MCW	Speaker Strobe - 15,30,75,110 cd, wall
E90-24MCC	Speaker Strobe - 15,30,75,95 cd, ceiling
E70-24MCWH	Speaker Strobe - 135,185 cd, wall
E90-24MCCH	Speaker Strobe - 115,177 cd, ceiling
ET70-241575	Speaker Strobe - 1575 cd, wall
ET70-24MCW	Speaker Strobe - 15,30,75,110 cd, wall
ET90-24MCC	Speaker Strobe - 15,30,75,95 cd, ceiling
ET70-24MCWH	Speaker Strobe - 135,185 cd, wall
ET90-24MCCH	Speaker Strobe - 115,177 cd, ceiling
ET80-24MCW	Speaker Strobe - vandal resist, 15,30,75,110 cd, wall

<b>Model Number Series</b>	<b>Description</b>
<b>ET80-24MCWH</b>	Speaker Strobe - vandal resist, 135,185 cd, wall
<b>ET70WP-2475</b>	Speaker Strobe - weatherproof
<b>HS-24</b>	Audible
<b>HS4-241575</b>	Audible Strobe - 1575 cd, wall
<b>HS4-24MCW</b>	Audible Strobe - 15,30,75,110 cd, wall
<b>HS4-24MCWH</b>	Audible Strobe - 135,185 cd, wall
<b>MIZ-24S</b>	Mini Horn - continuous, code-3, sync
<b>MT</b>	Multitone
<b>MT-121575, MT-241575, MT-24MCW</b>	Multitone Strobe - 1575 cd or 15,30,75,110 cd, wall
<b>MTWP-2475</b>	Multitone Strobe - weatherproof
<b>MTWP B or A</b>	Multitone Strobe - weatherproof-Blue or Amber lens
<b>NH</b>	Audible
<b>NS-24MCC</b>	Audible Strobe - 15,30,75,95 cd, ceiling
<b>NS-24MCCH</b>	Audible Strobe - 115, 177 cd, ceiling
<b>NS-24MCW</b>	Audible Strobe - 15,30,75,110 cd, wall
<b>NS-121575, NS-241575</b>	Audible Strobe - 1575 cd, wall
<b>RSS-121575</b>	Strobe-15,75 cd, wall
<b>RSS-241575, RSSP-241575</b>	Strobe - 15,75 cd, wall
<b>RSS-24MCW, RSSP-24MCW</b>	Strobe - 15,30,75,110 cd, wall
<b>RSS-24MCC, RSS-24MCCR</b>	Strobe - 15,30,75,95 cd, ceiling, round or square
<b>RSS-24MCWH, RSSP-24MCWH</b>	Strobe - 135,185 cd, wall
<b>RSS-24MCCH, RSS-24MCCHR</b>	Strobe - 115,177 cd, ceiling, round or square
<b>S8, S8-24MCC, S8-24MCCH</b>	Speaker or Speaker Strobe - 8-inch, ceiling

<b>Model Number Series</b>	<b>Description</b>
<b>SA-S90-24MCC</b>	Speaker Strobe - amplified, 15,30,75,95 cd, ceiling
<b>SA-S70-24MCW</b>	Speaker Strobe - amplified, 15,30,75,115 cd, wall
<b>STH w/opt strobe</b>	Cluster Speakers - with optional DC-MAX strobe
<b>STH MCCH</b>	Cluster Speakers - with 115/177 cd strobe
<b>STH-4R24MCCH110</b>	Cluster Speaker with three strobes
<b>STx</b>	Strobe - 15,15/75,30,75,95,110,135,185 cd, wall
<b>STxC</b>	Strobe - 15,30,60,75,95,115,150,177 cd, ceiling
<b>HSx</b>	Audible Strobe - 15,15/75,30,75,95,110,135,185 cd, wall
<b>HSxC</b>	Audible Strobe - 15,30,60,75,95,115,150,177 cd, ceiling
<b>HNx</b>	Audible, wall
<b>HNxC</b>	Audible, ceiling



## Authorized Releasing Valves

The extinguishant release output of the HCVR-3 Releasing Fire Control Panel is 1 Amp. All solenoids must operate using 1 amp or less. The solenoid releasing valves below are authorized for use as Fire Protection Service Valves on the HCVR-3 Releasing Fire Control Panel:

Manufacturers	Model
ASCO	HV2185328
ASCO	8210G207
Viking	11601
Viking	11602
Viking	11592
Viking	11591
Viking	11596
Viking	11595
Snap-Tite	2823A-2NB-A4F6
Sevo Systems	SOL EA45 same as Sevo Systems 510006, same as TLX Technologies PA0036-3
Kidde	K-45-8017 is equivalent to Kidde-Fenwall 486500-01
Kidde	B6793-859 is equivalent to Kidde-Fenwall 81-100000-001
Victaulic	Series 753-E FireLock
Fire Eater	305350 Ci IS8B Solenoid
Fire Eater	305451 Ci IS8B Solenoid and Manual

### Special Releasing Accessories

Manufacturer	Description	Model
Kentec Electronics	Sequential Activator	HCVR-SQA
FirePro	Fixed Condensed Aerosol Extinguishing System Units	FP-100S, FP-200S, FP-500S, FP-1200, FP-2000, FP-3000, FP-5700
Hochiki America	Fixed Condensed Aerosol Extinguishing System Units	FNX-100S, FNX-200S, FNX- 500S, FNX-1200, FNX-2000, FNX-3000, FNX-5700

Hochiki America Corporation  
 HCVR-3 Series - Conventional Fire Alarm Releasing System  
 Installation and Operation Manual, HA-06-294, Version V02.10

This page intentionally left blank.

## Appendix C

# Calculations

---

This section describes current-loading and the process for determining the standby-battery rating, the NAC wiring length and the releasing-circuit wiring length.

*Current loading calculations do not include the combined IDC currents of the HCVR3 Releasing Fire Control Panel. These combined IDC currents are negligible in comparison to fire control panel, ancillary device and NAC currents of the HCVR-3 Releasing Fire Control Panel and are therefore excluded from the current loading calculation.*

## Determining the Amp-Hour Rating

Installers must identify the load current for each device connected to the fire control panel. The sum of this current must be below the operating limits of the fire control panel and within the load capacity of the standby-batteries.

To determine the load rating of the fire control circuit:

- 1 Record the standby and alarm currents of the HCVR-3 Releasing Fire Control Panel.
- 2 Record the standby and alarm currents of the Status Display Units.
- 3 Record the standby and alarm currents of the Ancillary Boards.
- 4 Record the standby and alarm currents of Auxiliary Devices.
- 5 Record the alarm currents of NAC Devices.
- 6 Record the alarm currents of the Releasing Solenoids.
- 7 Total the standby and alarm currents of the HCVR-3 Releasing Fire Control Panel, Status Display Units, Ancillary Boards, Auxiliary Devices, NAC Devices and the Releasing Solenoid.
- 8 Calculate the Total Standby Amp Hours.
- 9 Calculate the Total Alarm Amp Hours.
- 10 Determine Total Amp-Hours by adding the Total Standby Amp Hours to the Total Alarm Amp Hours.
- 11 Determine the minimum Amp Hour rating for the battery by multiplying the Total Amp-Hours to the Derating Factor (1.20).
- 12 Verify that the rating determined from the Load Capacity Worksheet does not exceed the 7 AH capacity of the Standby-Batteries specified for operating the HCVR-3 Releasing Fire Control Panel.

Total standby-current of these loads must draw less than 236 mA to maintain continuous standby operation for twenty-four hours followed by five minutes of alarm.

Current loading calculations do not include the combined IDC currents of the HCVR-3 Releasing Fire Control Panel. These combined IDC currents are negligible in comparison to fire control panel, ancillary device and NAC currents of the HCVR-3 Releasing Fire Control Panel and are therefore excluded from the current loading calculation.

## Current-Loading

Current-loading of the HCVR-3 Releasing Fire Control Panel is limited to the 2.0 Amp capacity of the power supply and the 7 AH capacity of the standby-batteries. The standby-batteries can provide an operating duration of twenty-four hours followed by five minutes of alarm when the standby current does not exceed 236 mA.

Standby and alarm current can include all or part of the following loads but cannot exceed the total maximum currents specified:

Loads	Standby Current	Alarm Current
FACP	100 mA	620 mA
Status Display Unit	50 mA (per unit)	83 mA average per unit (max) 94 mA peak per unit (max)
Ancillary Board	16 mA (per board)	175 mA per board (max)
NAC Outputs	0 mA (per NAC output)	500 mA (per NAC output)
Releasing Output	0 mA	1000 mA
<b>Total Maximum Current</b>	236 mA	2000 mA

NAC outputs on the HCVR-3 Releasing Fire Control Panel are load dependant and are limited to a maximum current load of 500 mA. The releasing output on the HCVR-3 Releasing Fire Control Panel is load dependant and is limited to a maximum current load of 1000 mA.

Current limits are provided in *Appendix A, "Specifications"* for each of the circuit of the HCVR-3 Releasing Fire Control Panel. Installers must identify the current-draw of each device and then compare the sum of these device currents with the current limit provided for each circuit-output. The total device-current must be below the limits provided for each circuit output specified in *Appendix A, "Specifications"*.

The calculation of total-current-loading during an alarm condition includes the sum of device-loads on each power output circuit of the HCVR-3 Releasing Fire Control Panel. Power circuits of the fire control panel are provided on the terminals of NAC 1, NAC 2, and NAC 3, AUX 24V, STATUS DISPLAY UNITS and EXTING.

## NAC Wiring Length

Determine the maximum wire length that can safely operate Notification Appliances under worst case conditions. To determine the maximum wire length under worst case conditions:

- 1 Identify the minimum operating-voltage ( $V_{op_{min}}$ ) of Notification Appliances on the NAC channel.
- 2 Calculate the maximum current of the circuit ( $I_{max}$ ).
- 3 Identify the wire-resistance-per-foot of the circuit ( $R_{wire}$ ).
- 4 Calculate the maximum wire length ( $L_{max}$ ) of the circuit.

### Sample $L_{max}$ Calculation

The example calculation below illustrates the method for determining the maximum allowable wire length from the NAC1 output to the EOL resistor.

Determine the maximum wire length ( $L_{max}$ ) for three Notification Appliances on NAC channel 1 where,

- The manufacturer data sheet for the strobe indicates that the minimum operating-voltage ( $V_{op_{min}}$ ) is 16 VDC.
- The manufacturer data sheet for the strobe indicates that the maximum current-draw ( $I_{strobe}$ ) is 209mA DC.
- The circuit connection is provided with 18 AWG solid-copper-wire.
- The EOL resistor in the circuit is 10K Ohms.

To determine the maximum safe-wire-length ( $L_{max}$ ) of this circuit:

- 1 Identify the minimum operating-voltage ( $V_{op_{min}}$ ) of the strobe from the manufacturer data sheet.  
From the manufacturer data sheet:

$$V_{opmin} = 16 \text{ VDC}$$

- 2 Calculate the total current of the parallel devices in the circuit ( $I_{total}$ ) where,

$$\begin{aligned} [ I_{total} &= I_{strobe\_1} + I_{strobe\_2} + I_{strobe\_3} + (V_{op_{min}} / EOLD) ] \\ &= [ ( 0.209 + 0.209 + 0.209 + 16 / 10K ) ] \text{ A} \\ &= ( 0.627 + 0.0016 ) \text{ A} \end{aligned}$$

$$I_{total} = 0.6286 \text{ A}$$

- 3 Identify the maximum resistance of the wire gage used in the circuit ( $R_{wiremax}$ ) when using 18 AWG copper. An 18 AWG solid copper wire is 6.385 Ohms at 1000FT using the Resistance Table below:

Gage	Resistance / 1000Ft @ 68F	$R_{wire}$
18 AWG	6.385 Ohms	0.006385 Ohms / FT
16 AWG	4.016 Ohms	0.004016 Ohms / FT
14 AWG	2.525 Ohms	0.002525 Ohms / FT

- 4 The calculation for the minimum output voltage of the NAC is:

$$V_{outmin} = V_{panel} \times 85\%$$

$$= 24 \text{ VDC} \times 85\%$$

$$V_{outmin} = 20.4 \text{ VDC}$$

- 5 The calculation for voltage-drop across the length of the wire is:

$$V_{drop} = V_{outmin} - V_{opmin}$$

$$= 20.4 \text{ VDC} - 16 \text{ VDC}$$

$$V_{drop} = 4.4 \text{ VDC}$$

- 6 The calculation for maximum wire length of this circuit is:

$$L_{max} = 1/2 ( V_{drop} / I_{max} ) / R_{wire}$$

where,

$$= 1/2 [ ( 4.4 / 0.6286 ) / ( 0.006385 \text{ Ohms / FT } ) ]$$

$$L_{max} = 548 \text{ FT}$$

The figure below illustrates an example circuit for determining maximum wire length where values are provided for minimum operating-voltage of the NAC channel output ( $V_{opmin}$ ), maximum current of the circuit ( $I_{max}$ ), wire-resistance-per-foot of the circuit ( $R_{wire}$ ) and maximum current-draw of the strobe ( $I_{strobe}$ ):

**Figure C-1**  
**Example Circuit For Determining Maximum Wire Length**

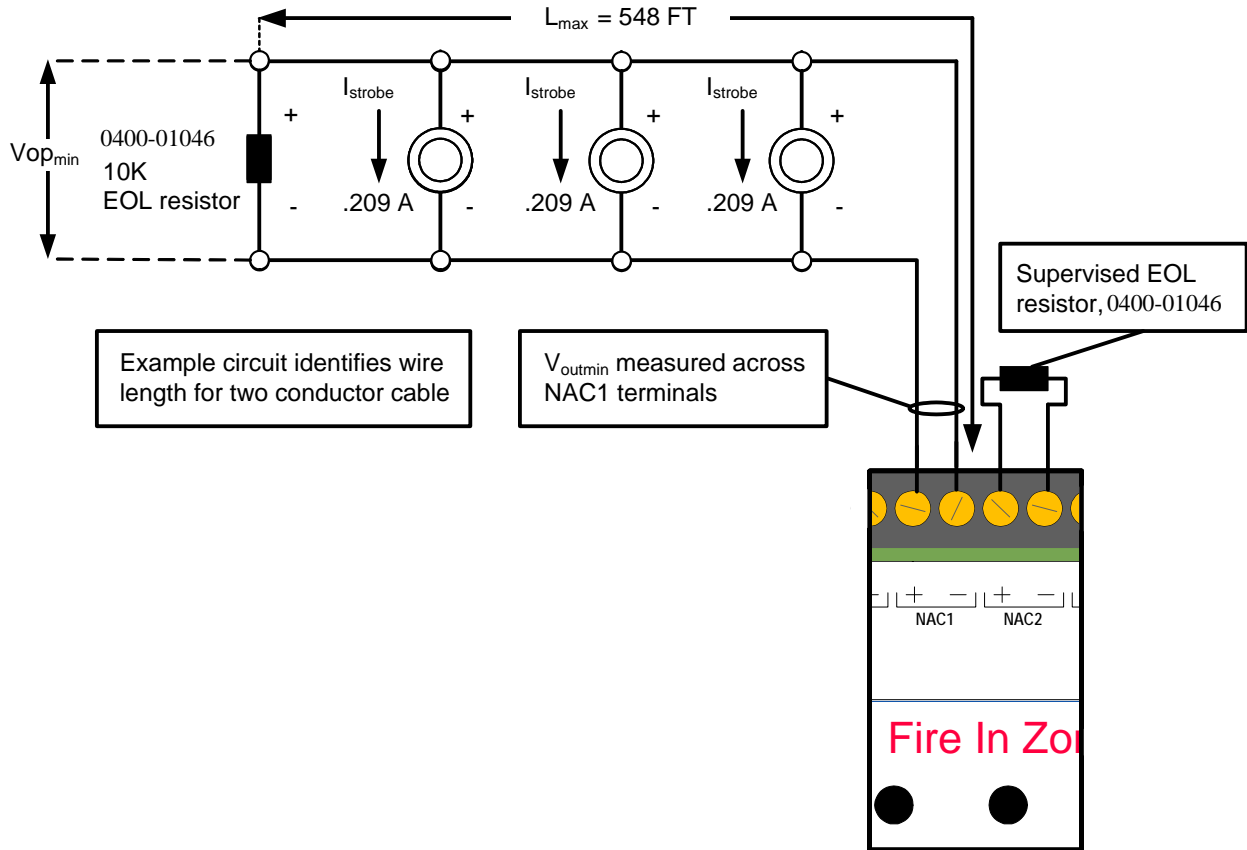

## Releasing-Circuit Wiring Length

The releasing-valve is dependant on sufficient releasing-voltage at the solenoid-terminals to provide actuation. Releasing-valve actuation cannot occur when losses in the releasing circuit prevent sufficient voltage from occurring at the solenoid-terminals. Installers must determine the maximum wire length that can safely provide operating voltage at the solenoid terminals to negate losses of the releasing circuit.

Determine the maximum wire length that can safely operate a Fire Protection Service Valve.

To determine the maximum wire length of the releasing circuit:

- 1 Calculate the minimum voltage ( $V_{out_{min}}$ ) at the EXTING. terminals of the HCVR-3 Releasing Fire Control Panel.
- 2 Calculate the minimum operating-voltage ( $V_{op_{min}}$ ) of the Solenoid Release Valve (SRV).
- 3 Calculate the voltage-drop of the circuit ( $V_{drop}$ ) when the EXTING. output is at the minimum level ( $V_{out_{min}}$ ) and when the operating-voltage of the SRV is at the minimum level ( $V_{op_{min}}$ ).
- 4 Calculate the maximum current of the circuit ( $I_{max}$ ) when the SRV operates at the minimum level ( $V_{op_{min}}$ ).
- 5 Determine the wire-resistance-per-foot of the cabling ( $R_{wire}$ ) in the circuit.
- 6 Calculate the maximum wire length ( $L_{max}$ ) of the circuit when connecting the SRV to the EXTING. terminals.

### Summary of Parameters

The table below summaries parameters for determining the maximum wire length ( $L_{max}$ ) of the circuit:

Parameter	Description	Equation
$V_{out_{min}}$	Minimum voltage at the EXTING. Output. <i>UL 864 specifies that the HCVR-3 Releasing Fire Control Panel operate a minimum output-voltage 85% below the nominal rating.</i>	$V_{out_{min}} = V_{out_{nominal}} \times 85\%$
$V_{op_{min}}$	Minimum operating-voltage of the SRV. <i>UL 429 specifies that the SRV operate a minimum voltage 65% below the nominal rating.</i>	$V_{op_{min}} = V_{SRV_{nominal}} \times 65\%$



Parameter	Description	Equation
$V_{\text{drop}}$	Allowable voltage loss of the circuit between the voltage source and the SRV.	$V_{\text{drop}} = V_{\text{out}_{\text{min}}} - V_{\text{op}_{\text{min}}} - V_{\text{EOLD}}$
$I_{\text{max}}$	Maximum current of the circuit when the SRV is operating at minimum level.	$I_{\text{max}} = WSRV_{\text{max}} / V_{\text{op}_{\text{min}}}$
$R_{\text{wire}}$	Resistance-per-foot of the wire gage specified for the circuit.	<i>Reference the wire gauge resistance table provided in this section.</i>
$L_{\text{max}}$	Maximum wire length of the circuit.	$L_{\text{max}} = 1/2 [ (V_{\text{drop}} / I_{\text{max}}) / R_{\text{wire}} ]$

### Sample $L_{\text{max}}$ Calculation

The example calculation below illustrates the method for determining the maximum allowable wire length from the EXTING. output to a Solenoid Releasing Valve (SRV).

Determine the maximum wire length ( $L_{\text{max}}$ ) of the circuit from the EXTING. terminals to an authorized SRV where,

- The circuit connection is provided with 18 AWG solid copper wire.
- The maximum power rating for the SRV ( $WSRV_{\text{max}}$ ) is 9.11 Watts.
- The nominal output-voltage for the HCVR-3 Releasing Fire Control Panel ( $V_{\text{out}_{\text{nominal}}}$ ) is 24 VDC.
- The nominal operating-voltage for the SRV ( $V_{\text{SRV}_{\text{nominal}}}$ ) is 24 VDC.
- The EOL diode provides a voltage drop ( $V_{\text{EOLD}}$ ) of 0.7 VDC

To determine the maximum wire length ( $L_{\text{max}}$ ) of the SRV circuit:

- 1 Calculate the minimum voltage ( $V_{\text{out}_{\text{min}}}$ ) at the EXTING. terminals when the voltage output is 85% of the nominal rating.

where,

$$\begin{aligned} V_{\text{out}_{\text{min}}} &= V_{\text{out}_{\text{nominal}}} \times 85\% \\ &= 24 \text{ VDC} \times 0.85 \end{aligned}$$

$$V_{\text{out}_{\text{min}}} = 20.4 \text{ VDC}$$

- 2 Calculate the minimum operating-voltage ( $V_{SRV_{min}}$ ) of the Solenoid Release Valve (SRV) when it is 65% of the nominal rating.

where,

$$\begin{aligned} V_{op_{min}} &= V_{SRV_{nominal}} \times \%V_{out} \\ &= 24 \text{ VDC} \times 0.65 \end{aligned}$$

$$V_{op_{min}} = 15.6 \text{ VDC}$$

- 3 Calculate the voltage-drop of the circuit ( $V_{drop}$ ) when the EXTING. output is at the minimum level ( $V_{out_{min}}$ ) and when the operating-voltage of the SRV is at the minimum level ( $V_{SRV_{min}}$ ).

where,

$$\begin{aligned} V_{drop} &= V_{out_{min}} - V_{op_{min}} - V_{EOLD} \\ &= 20.4 \text{ VDC} - 15.6 \text{ VDC} - .07 \text{ VDC} \end{aligned}$$

$$V_{drop} = 4.1 \text{ VDC}$$

- 4 Calculate the maximum current of the circuit ( $I_{max}$ ) when the SRV operates 65% below its nominal operating-voltage and power across the SRV is maximum.

where,

$$I_{max} = W_{SRV_{max}} / V_{op_{min}}$$

Refer to the manufacturer specifications of the SRV for the maximum power rating ( $W_{SRV_{max}}$ ).

$$= 9.11 \text{ W} / 15.6 \text{ VDC}$$

$$I_{max} = 584 \text{ mA}$$

- 5 Identify the resistance-per-foot of the wire gage used in the circuit ( $R_{wiremax}$ ) when using 18 AWG copper. The table below describes the resistance-per-foot of an 18 AWG solid-copper-wire:

Gage	Resistance / 1000Ft @ 68F	$R_{wire}$
18 AWG	6.385 Ohms	0.006385 Ohms / FT
16 AWG	4.016 Ohms	0.004016 Ohms / FT
14 AWG	2.525 Ohms	0.002525 Ohms / FT

$$R_{wire} = 0.006385 \text{ Ohms / FT}$$

- 6 The calculation for maximum wire length of this SRV circuit is:

$$L_{max} = 1/2 ( V_{drop} / I_{max} ) / R_{wire}$$

where,

$$= 1/2 [ ( 4.1 \text{ VDC} / 0.584 \text{ A} ) / ( 0.006385 \text{ Ohms / FT} ) ]$$

$$L_{max} = 550 \text{ FT}$$

The figure below illustrates the maximum wire length example of the SRV circuit:

**Figure C-3**  
**Maximum Wire Length Example**

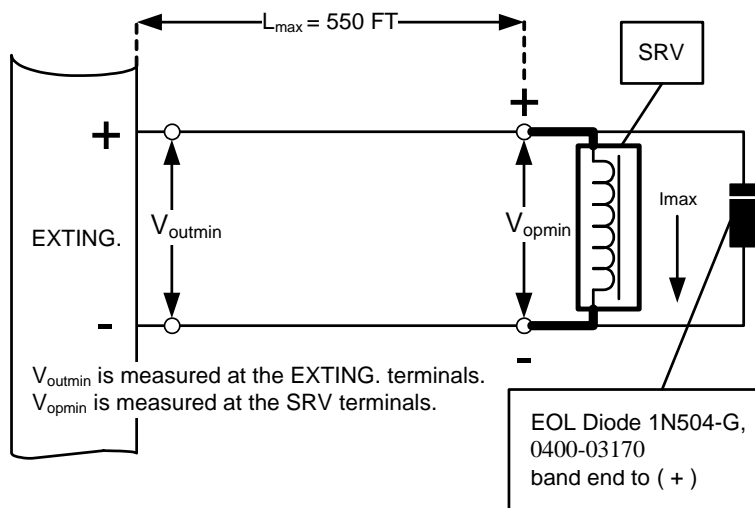

This page intentionally left blank.

**Appendix D**  
**Wiring Diagram**

**Wiring Diagram**

This wiring diagram describes circuit connections for all models of the HCVR-3 Releasing Fire Control Panel.

The operation of this product is intended for indoor use only.

Contents	Page
Front View, Wire Gauge and Related Documentation.....	2
Connection Diagram.....	3
Main Supply Circuit .....	4
Rechargeable Battery Circuit .....	5
Ground Fault Indications .....	6
Power Output Circuits .....	7
Limited-Energy Circuits .....	7
Supervised Circuits .....	7
Initiating Device Circuit .....	8 - 9
Notification Appliance Circuit .....	10 -13
Releasing-Device Circuits .....	14
Abort Function .....	15
Status Units (Data and Power) .....	16
Relay Circuits .....	17
AUX 24V .....	17



Part Number: HCVR-3 Wiring Diagram, 1700-05952  
Revision V2.00, Date: 11/29/2012

**Hochiki America Corporation**  
**HCVR-3 Series - Conventional Fire Alarm Releasing System**  
**Installation and Operation Manual, HA-06-294, Version V02.10**

## Front View, Wire Gauge and Related Documentation of the HCVR-3 Releasing Fire Control Panel

### Front View

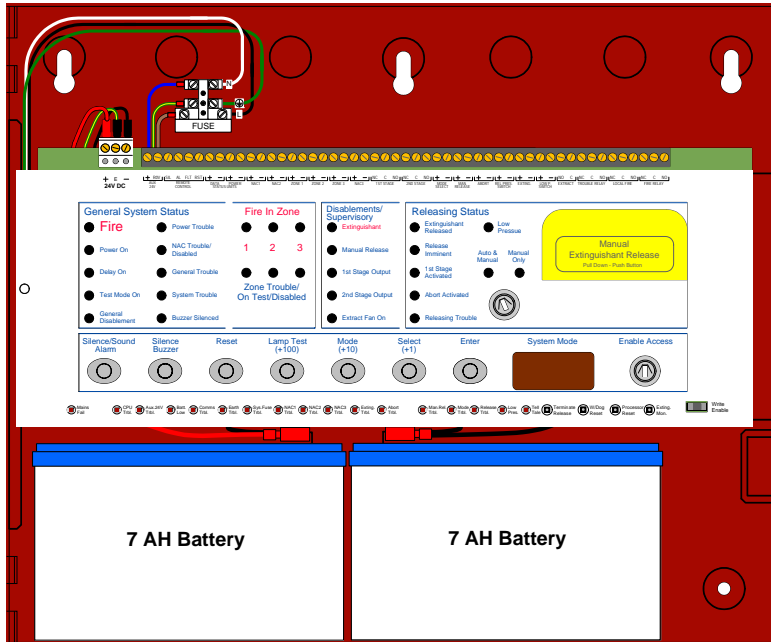

### Wire Gauge

Connect 18 to 14 AWG wiring for all field terminations except the AC input. Connect 14 AWG wiring for line, neutral and ground terminations of the AC input.

### Related Documentation

The following documents shall be used to provide additional information for installing and operating the HCVR-3 Releasing Fire Control Panel:

- ❖ Installation and Operation Manual, HA-06-294, V1.XX
- ❖ Operating Instructions, HA-06-295, V1.XX
- ❖ UL Compliance Label, 1700-05960, V1.XX

Part Number: HCVR-3 Wiring Diagram, 1700-05952  
Revision V2.00, Date: 11/29/2012



<b>Main Supply Circuit</b>		
<b>Line Connection</b>		
<b>Terminals</b>	<b>Description</b>	<b>Voltage</b>
<b>L</b>	AC Line	115 VAC @ 50 / 60Hz
		230 VAC @ 50 / 60Hz
<b>N</b>	AC Neutral	
<b>G</b> 	Earth-Ground	
<b>Power Supply</b>		
<b>Rating</b>		115 VAC - 125 VA 230 VAC - 126 VA
<b>AC Input Fuse</b>		1.6 Amp, 250 VAC, slow-blow, 5 x 20mm
<b>Input (Supervised)</b>		115 or 230 VAC 50/60Hz
<b>Transfer Voltage</b>		115 VAC transfer @ 90 VAC, 230 VAC transfer @ 180 VAC

Part Number: HCVR-3 Wiring Diagram, 1700-05952  
Revision V2.00, Date: 11/29/2012



<b>Rechargeable Battery Circuit</b>	
<b>Standby-Battery Type</b>	Two 12 VDC, 7 AH, sealed lead acid, batteries
<b>Standby-Battery Charging</b>	Two standby batteries wired in series
<b>Charge Current</b>	700 mA maximum
<b>Output Current</b>	0 - 2 Amps
<b>Standby-Operating Time</b>	24 Hours
<b>Battery Charge Voltage</b>	27.6 VDC
<b>Fire Control Panel Current Draw From Battery While In Mains Fail, Standby And Not in Alarm</b>	100 mA with buzzer sounding
<b>Maximum Current Draw of FACP, In Alarm</b>	620 mA (Current does not include loads from NACs, Solenoid, Status Units, Ancillary Boards and Auxiliary equipment)
<b>Maximum Current Draw From Batteries</b>	2 Amps

Part Number: HCVR-3 Wiring Diagram, 1700-05952  
Revision V2.00, Date: 11/29/2012

## Ground Fault Indications

A ground fault indication occurs when 30K Ohms or less exists between earth-ground and the following field terminals of the HCVR-3 Releasing Fire Control Panel:

- ❖ AUX 24V
- ❖ POWER, STATUS UNITS
- ❖ NAC 1, NAC 2 and NAC 3
- ❖ ZONE 1, ZONE 2, ZONE 3
- ❖ MODE SELECT
- ❖ MAN RELEASE
- ❖ ABORT
- ❖ REL. PRES. SWITCH
- ❖ EXTING.
- ❖ LOW P. SWITCH
- ❖ DATA, STATUS UNITS

Part Number: HCVR-3 Wiring Diagram, 1700-05952  
Revision V2.00, Date: 11/29/2012

## Power Output Circuits

Special application outputs are provided on the following terminals of the HCVR-3 Releasing Fire Control Panel :

- ❖ NAC 1
- ❖ NAC 2
- ❖ NAC 3
- ❖ AUX 24V
- ❖ POWER, STATUS UNITS
- ❖ EXTING

## Limited Energy Circuits

All circuits of the HCVR-3 Releasing Fire Control Panel are power limited except AC input/output, battery, transformer input/output and bridge rectifier input/output.

## Supervised Circuits

All circuits of the HCVR-3 Releasing Fire Control Panel are supervised except relay terminals for 1ST STAGE, 2ND STAGE, EXTRACT, TROUBLE RELAY, LOCAL FIRE and FIRE RELAY.

Part Number: HCVR-3 Wiring Diagram, 1700-05952  
Revision V2.00, Date: 11/29/2012

<b>Initiating Device Circuit</b>	
Initiating Device Circuits are Class B, Style C	
Authorized initiating devices are two-wire smoke and closed-contact-type detectors.	
<b>Terminals</b>	
<b>ZONE 1</b> <b>ZONE 2</b> <b>ZONE 3</b>	Supervised input: 6.8K Ohm EOL resistor 0400-03140, 470 Ohm trigger resistor 0400-03150 and 270 Ohm series resistor, 0400-03160.  Detectors – 270 Ohm Pull Stations - 470 Ohm
<b>MODE SELECT</b> <b>MAN. RELEASE</b> <b>ABORT</b> <b>REL. PRESS. SWITCH</b> <b>LOW PRESS. SWITCH</b>	Supervised input: 6.8K Ohm EOL resistor 0400-03140 and 470 Ohm trigger resistor 0400-03150.  Mode Select must include the 6.8K Ohm EOL resistor 0400-03140 to maintain the supervised input. The Mode Select is a no connection terminal (NC). The 470 Ohm trigger resistor is not required for these no connection (NC) terminals.
<b>EXTING.</b>	Supervised output: 1N504-G EOL diode
Pull stations authorized for use with the HCVR-3 Releasing Fire Control Panel are non-addressable and UL listed.	

Part Number: HCVR-3 Wiring Diagram, 1700-05952  
 Revision V2.00, Date: 11/29/2012

<b>Initiating Device Circuit</b>	
<b>Adjustable</b>	
<b>Extinguishant Output Delay</b>	Adjustable 0 to 60 seconds (+/- 10%) in 5 second intervals
<b>Extinguishant Duration</b>	Adjustable 60 to 300 seconds (+/- 10%) in 5 second intervals
<b>Short Circuit Threshold</b>	Adjustable
<b>Remote Control Inputs</b>	No Connect (NC) terminals.
<b>Mode Select</b>	No Connect (NC) terminal
<b>Ratings</b>	
<b>Maximum Operating Voltage</b>	21.6 VDC
<b>Maximum Short Circuit Current</b>	65 mA
<b>Maximum Line Impedance</b>	20.3 Ohms

Part Number: HCVR-3 Wiring Diagram, 1700-05952  
Revision V2.00, Date: 11/29/2012

<b>Notification Appliance Circuit</b>	
<b>Polarized Appliance Requirement</b>	NAC outputs of the HCVR-3 Releasing Fire Control Panel accept devices that are polarized only. A trouble condition is reported when non-polarized NAC devices are connected to these NAC outputs. Field connections must include symbol-markings for plus (+) and minus (-) on all polarized appliance terminations.
<b>Connection</b>	<b>Rating</b>
<b>NAC 1 and NAC 2 (+), (-)</b>	Special Application: 18 to 28 VDC @ 500 mA continuous Regulated: 18 to 28 VDC @ 50 mA continuous Fused: Electronic 1.1 A Supervision: Voltage reversing DC Short Circuit Threshold: 130 Ohms +/- 20% Maximum line-voltage-drop: 2 VDC Class B, Style Y operation
<b>NAC 3 (+), (-)</b>	Releasing Output Only Special Application: 18 to 28 VDC @ 500 mA pulsed and continuous Regulated: 18 to 28 VDC @ 50 mA pulsed and continuous Fused: Electronic 1.1 A Supervision: Voltage reversing DC Short Circuit Threshold: 130 Ohms +/- 20% Maximum line-voltage-drop: 2 VDC Class B, Style Y operation

Part Number: HCVR-3 Wiring Diagram, 1700-05952  
 Revision V2.00, Date: 11/29/2012

## Notification Appliance Circuit

### NAC Synchronization

The HCVR-3 Releasing Fire Control Panel supports special application outputs of NAC 1 and NAC 2 when operating:

- ❖ Amseco NAC devices with Amseco synchronization modules
- ❖ Gentex NAC devices with Gentex synchronization modules
- ❖ System Sensor NAC devices with System Sensor synchronization modules
- ❖ Wheelock NAC devices with Wheelock synchronization modules

NAC channels 1 and 2 of the HCVR-3 Releasing Fire Control Panel provide single and dual circuit synchronization. Single circuit synchronization provides a synchronized output on one channel of two NAC channels. Dual circuit synchronization provides a synchronized output on NAC 1 and NAC 2.

### Maximum Current

A maximum current of 1.5 Amps is available for powering NAC 1, NAC 2 and NAC 3 when a maximum load of 500 mA exists on any one of the NAC outputs.

## Notification Appliance Circuit

The following statements for NAC synchronization are necessary for UL qualification and exclude device-loading combinations that are common in most FACP installations:

<b>Amseco</b>	NAC 1 and NAC 2 of the HCVR-3 Releasing Fire Control Panel can each operate a maximum of seven Amseco SL-1224 strobes when configured for 15cd outputs and synchronized with an Amseco SMD10-3A synchronization module.
<b>Gentex</b>	NAC 1 and NAC 2 of the HCVR-3 Releasing Fire Control Panel can each operate a maximum of six Gentex GES3-24 strobes when configured for 15cd outputs and synchronized with a Gentex AVSM synchronization module.
<b>System Sensor</b>	NAC 1 and NAC 2 of the HCVR-3 Releasing Fire Control Panel can each operate a maximum of eight System Sensor S1224MC strobes when configured for 15cd outputs and synchronized with a System Sensor MDL synchronization module.
<b>Cooper/Wheelock</b>	NAC 1 and NAC 2 of the HCVR-3 Releasing Fire Control Panel can each operate a maximum of eight Cooper/Wheelock RSS-24MCW strobes when configured for 15cd outputs and synchronized with a Cooper/Wheelock SM-24 synchronization module.

Part Number: HCVR-3 Wiring Diagram, 1700-05952  
Revision V2.00, Date: 11/29/2012



## Notification Appliance Circuit

NAC outputs of the HCVR-3 Releasing Fire Control Panel are not limited by conditions other than the maximum rated current threshold. NAC outputs of the HCVR-3 Releasing Fire Control Panel can operate combinations of Hochiki authorized NAC devices as long as the circuit load does not exceed 500 mA.

*Reference manufacturer data sheets for individual device loads and then total the loads to determine if the sum exceeds the 500 mA threshold of each NAC output.*

Part Number: HCVR-3 Wiring Diagram, 1700-05952  
Revision V2.00, Date: 11/29/2012

## Releasing Device Circuits

<b>Exting.</b>	Releasing output: 18 to 28 VDC, with 1.0 Amp maximum load for 5 minutes and voltage reversing DC. Maximum line-voltage-drop: 2.4 VDC Fused at 1.6 Amps
----------------	---

### Authorized Releasing Valves

<b>Manufacturers</b>	<b>Models</b>
<b>ASCO</b>	HV2185328
<b>ASCO</b>	8210G207
<b>Viking</b>	11601
<b>Viking</b>	11602
<b>Viking</b>	11592
<b>Viking</b>	11591
<b>Viking</b>	11596
<b>Viking</b>	11595
<b>Snap-Tite</b>	2823A-2NB-A4F6
<b>Sevo Systems</b>	SOL EA45, The SOL EA45 is equivalent to Sevo Systems 510006 and TLX Technologies PA0036-3
<b>Kidde</b>	K-45-8017, The K-45-8017 is equivalent to Kidde-Fenwall 486500-01
<b>Kidde</b>	B6793-859, The B6793-859 is equivalent to Kidde-Fenwall 81-100000-001
<b>Victaulic</b>	Series 753-E FireLock
<b>Fire Eater</b>	305450 Ci IS8B Solenoid
<b>Fire Eater</b>	305451 Ci IS8B Solenoid and Manual

The extinguishant release output of the HCVR-3 Releasing Fire Control Panel is 1 Amp. All solenoids must operate using 1 amp or less. The solenoid releasing valves above are authorized for use as Fire Protection Service Valves on the HCVR-3 Releasing Fire Control Panel.

Part Number: HCVR-3 Wiring Diagram, 1700-06952  
Revision V2.00, Date: 11/29/2012

**Abort Function**

<b>Override Operation</b>	<p>The abort function overrides the manual release when the manual release is activated before the abort.</p> <p>The manual release overrides the abort function when the abort is activated before the manual release.</p>
<b>Connection</b>	Monitored input EOL 6.8K Ohm +/- 5% resistor, 0400-03140, activation impedance 470 Ohms

Part Number: HCVR-3 Wiring Diagram, 1700-05952  
Revision V2.00, Date: 11/29/2012

<b>Status Units (Data and Power)</b>	
<b>Data</b>	
<b>RS485 Serial Bus</b>	Two-wire RS485, Maximum line impedance 120 Ohms, SLC Class B Style 4
<b>Connector Terminals</b>	14 to 18 AWG wire
<b>Maximum Number of Units</b>	Maximum Number of Units 7 Status Units, 7 Ancillary Boards. A separate power source must be used if the total-load-current at the STATUS UNIT, POWER terminals exceed 500 mA.
<b>Power</b>	
<b>Maximum Output Rating</b>	Maximum Output Rating 18 to 28 VDC, 1.1 A electronic fuse, 500 mA maximum load
<b>Connector Terminals</b>	14 to 18 AWG wire
<b>Maximum Number of Units</b>	Load dependant, 500 mA maximum in alarm

Part Number: HCVR-3 Wiring Diagram, 1700-05952  
Revision V2.00, Date: 11/29/2012

<b>Relay Circuits</b>	
<b>Operation</b>	Common
<b>Current</b>	1A maximum, volt free change over contact
<b>Voltage</b>	30 VDC
<b>Power Factor</b>	1.0 PF

















<b>AUX 24V</b>	
<b>Terminal</b>	<b>Rating</b>
<b>AUX 24V (+ / R0V)</b>	18 – 28 VDC Special Application output, 500 mA maximum









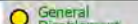













Part Number: HCVR-3 Wiring Diagram, 1700-05952  
Revision V2.00, Date: 11/29/2012

This page intentionally left blank.











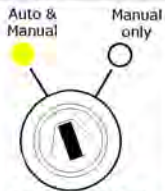
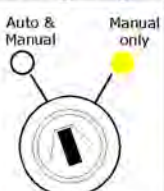





## Appendix E Operating Instructions



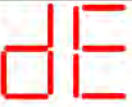















This section provides operating instructions, HA-06-295 for the HCVR-3 Releasing Fire Control Panel. These operating instructions shall be placed on the cabinet-front or on a separate sheet that can be framed and located adjacent to the control unit:







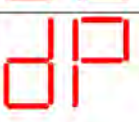











How To	Do This	Display	Comments
Test lamps	 <b>Lamp Test</b> Press button	 All lamps on	Buzzer sounds whilst button is pressed
Silence buzzer	 <b>Silence Buzzer</b> Press button		
Enable buttons	 <b>Enable Access</b> Insert key and turn		Buzzer beeps twice every seven seconds
Silence alarms	 <b>Silence/Sound Alarm</b> Press button		
Sound alarms	 <b>Silence/Sound Alarm</b> Press button		Buzzer beeps urgently
Reset	 <b>Reset</b> Press button	All trouble indicators flash for 3 seconds	Resets fire detection system. Extinguishant system will reset only after the extinguishant has been released
Disable a zone step 1	 <b>Mode</b> Press button till d1 displayed	 First display	
Disable a zone step 2	 <b>Select</b> Press button to scroll zones	 Zone 2	
Disable a zone step 3	 <b>Enter</b> Press button	 Zone 2 fault LED lit	 Dot flashes when disabled





How To	Do This	Display	Comments
Put a zone into test mode step 1	 Mode Press button till t1 displayed	 First display	
Put a zone into test mode step 2	 Select Press button to scroll zones	 Zone 2	
Put a zone into test mode step 3	 Enter Press button	 Zone 2 trouble LED lit	  Dot flashes when disabled
Enable a zone step 1	 Mode Press button till d1 displayed	 First display	
Enable a zone step 2	 Select Press button to scroll zones	 Zone 2	Disabled zones will have flashing dot.
Enable a zone step 3	 Enter Press button	 Zone fault LED off	 Dot stops flashing when enabled
Exit test mode step 1	 Mode Press button	 First display	
Exit test mode step 2	 Select Press to scroll zones	 Zone 2	Zones in test mode will have flashing dot
Exit test mode step 3	 Enter Press button	 Zone 1 trouble LED off	 Dot stops flashing when test mode exited

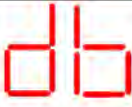

How To	Do This	Display	Comments
Change from Manual only to Automatic and Manual and vice versa	 <p>Auto &amp; Manual      Manual only</p> <p>Insert key and turn</p>	 <p>Auto &amp; Manual      Manual only</p>	
Start Extract fan	 <p>Insert key and turn</p>		
Press Mode button till Ac appears in display	 <p>Enter Press button</p>		
Press Enter button again to turn extract fan on	 <p>Enter Press button</p>		Dot flashes to indicate extract active.
Press Enter button again to turn extract fan off	 <p>Enter Press button</p>		Dot stops flashing to indicate extractive inactive
Manually release the extinguishant <b>CAUTION</b>	 <p>Manual Extinguishant Release PULL DOWN FLAP TO RELEASE EXTINGUISHER</p> <p>Pull down flap and press button to release extinguishant</p>		Extinguishant will release after time displayed in seconds on the countdown timer
Disable extinguishant control step 1	 <p>Mode Press mode button till dE is displayed</p>		
Disable extinguishant control step 2	 <p>Enter Press button</p>		Dot flashes to indicate extinguishant control is disabled
Enable extinguishant control step 1	 <p>Mode Press mode button till dE is displayed</p>		Flashing dot indicates extinguishant control disabled
Enable extinguishant control step 2	 <p>Enter Press button</p>		Dot stops flashing to indicate extinguishant control enabled

How To	Do This	Display	Comments
Disable manual release step 1	 <b>Mode</b> Press mode button till dt is displayed		
Disable manual release step 1	 <b>Enter</b> Press button		Dot flashes to indicate Manual release is disabled
Enable Manual release step 1	 <b>Mode</b> Press mode button till dt is displayed		Flashing dot indicates Manual release disabled
Enable Manual release step 2	 <b>Enter</b> Press button		Dot stops flashing to indicate Manual release enabled
Disable extract fan step 1	 <b>Mode</b> Press mode button till dc is displayed		
Disable extract fan step 2	 <b>Enter</b> Press button		Dot flashes to indicate Extract fan is disabled
Enable extract fan step 1	 <b>Mode</b> Press mode button till dc is displayed		Flashing dot indicates extract fan disabled
Enable extract fan step 2	 <b>Enter</b> Press button		Dot stops flashing to indicate Extract fan enabled
Disable first stage relay output step 1	 <b>Mode</b> Press mode button till dP is displayed		
Disable first stage relay output step 2	 <b>Enter</b> Press button		Dot flashes to indicate first stage relay output is disabled

How To	Do This	Display	Comments
Enable first stage relay output step 1	 <b>Mode</b> Press mode button till dP is displayed		Flashing dot indicates first stage relay output disabled
Enable first stage relay output step 2	 <b>Enter</b> Press button		Dot stops flashing to indicate first stage relay output enabled
Disable second stage relay output step 1	 <b>Mode</b> Press mode button till dA is displayed		
Disable second stage relay output step 2	 <b>Enter</b> Press button		Dot flashes to indicate second stage relay output is disabled
Enable second stage relay output step 1	 <b>Mode</b> Press mode button till dP is displayed		Flashing dot indicates second stage relay output disabled
Enable second stage relay output step 2	 <b>Enter</b> Press button		Dot stops flashing to indicate second stage relay output enabled
Disable first stage sounders step 1	 <b>Mode</b> Press mode button till db is displayed		
Disable first stage sounders step 1	 <b>Enter</b> Press button		Dot flashes to indicate first stage sounders are disabled
Enable first stage sounders step 1	 <b>Mode</b> Press mode button till db is displayed		Flashing dot indicates first stage sounders disabled
Enable first stage sounders step 2	 <b>Enter</b> Press button		Dot stops flashing to indicate first stage sounders enabled

How To	Do This	Display	Comments
<b>Step 1</b> Reset the fire control panel after an abort function	<p><b>Enable Access</b></p>  <p>Insert key and turn</p> <p>Press and hold Abort switch while turning Enable Access key to the right.</p>	<p><b>Fire in Zone</b></p> 	Buzzer sounds.
<b>Step 2</b>	 <p><b>Reset</b></p> <p>Press button</p>		Fire Control Panel resets after pressing the Reset button. Fire In Zone LED indicators are not illuminated.  Buzzer is silenced.  Release and Abort conditions have been terminated.
<b>Step 3</b>	<p><b>Enable Access</b></p>  <p>Insert key and turn</p> <p>Turn Enable Access key to the left.</p>		LED display of step 2 is blank.

## Inspecting Batteries

Inspect the standby-batteries annually to determine the connection integrity to the HCVR-3 Releasing Fire Control Panel. The fire control panel contains sealed lead acid batteries to provide standby power in the event of mains failure. The standby-batteries have a life expectancy of 3 to 5 years. Test the standby-batteries annually in accordance with the battery manufacturer’s recommendations to determine their suitability for continued standby operation.

## Replacing Standby-Batteries

Replace standby-batteries when the service period reaches 3 to 5 years or when the low-battery indicator illuminates on the power supply. Specify replacement batteries that are Power Sonic model PS-1270 F2, sealed-lead-acid, 12 VDC and 7 AH.

## Related Documentation

The following documents shall be used to provide additional information for installing and operating the HCVR-3 Releasing Fire Control Panel:

- Installation and Operation Manual, HA-06-294, V1.XX
- Wiring Diagram, 1700-05952, Revision V1.XX
- UL Compliance Label, 1700-05960, Revision V1.XX

## Emergency Contact

IN THE EVENT OF TROUBLE	
<b>CONTACT</b>	
<b>NAME</b>	
<b>ADDRESS</b>	
<b>CITY</b>	
<b>STATE</b>	
<b>ZIP</b>	
<b>TELEPHONE</b>	

This page intentionally left blank.

Appendix F  
**UL Compliance Label**

<b>UL Compliance</b>	
<b>Manufacturer</b>	UL File S8485
<b>Model Numbers</b>	HCVR-3 Series
<b>Product Use</b>	Commercial protected-premises control unit
<b>Fire Alarm System</b>	Local Signaling Unit and Releasing
<b>NFPA Codes</b>	NFPA 12, NFPA 12A, NFPA 15, NFPA 17, NFPA 17A, NFPA 72 and NFPA 2001
<b>Alarm Signals Processed</b>	Types of signaling services are SLC Class B, Style 4, NFPA 72 conventional IDC Class B, Style C or Class B, Style B, automatic fire alarm, manual fire alarm
<b>Signaling Type</b>	Non-coded Signaling
<b>Installation Manual</b>	For HCVR-3 series reference HA-06-294, version V02.XX
<b>Operating Instructions</b>	For HCVR-3 series reference HA-06-295, version V02.XX
<b>Wiring Diagram</b>	For HCVR-3 series reference 1700-5952, version V02.XX
<b>Compatibility ID</b>	AXT0110
<b>Power Limited Circuits</b>	All circuits are power limited except AC, battery, transformer and bridge rectifier input/output.
<b>Software Release</b>	XTUS_ <input type="text"/>
<b>Installation Environment</b>	For dry indoor use only
<b>Label</b>	1700-05960, V02.00, Date: 12/3/2012

Hochiki America Corporation  
 HCVR-3 Series - Conventional Fire Alarm Releasing System  
 Installation and Operation Manual, HA-06-294, Version V02.10

This page intentionally left blank.



**Appendix G**  
**UL 864 Permitted Configurations**

Notice To Users, Installers, Authorities Having Jurisdiction, and other involved parties.  
 This product incorporates field-programmable software. In order for the product To comply with the requirements in the Standard for Control Units and Accessories for Fire Alarm Systems, UL 864 10th Edition, certain programming features or options must be limited To specific values or not used at all as indicated below.

<b>Program Feature or Option</b>	<b>Permitted in UL 864 ? (Y/N)</b>	<b>Possible Settings</b>	<b>Settings Permitted In UL 864</b>
<b>NAC Output Delay</b> <b>Code: C00 To C09</b>	N	30 seconds - 9 minutes	0 minutes
<b>Zone 1 and Zone 2 Detectors Trigger Automatic Release</b> <b>Code: C11</b>	Y	Enable / Disable	Enable / Disable
<b>Zone 2 and Zone 3 Detectors Trigger Automatic Release</b> <b>Code: C12</b>	Y	Enable / Disable	Enable / Disable
<b>Zone 1 and Zone 3 Detectors Trigger Automatic Release</b> <b>Code: C13</b>	Y	Enable / Disable	Enable / Disable
<b>Zone 1 and Zone 2 or Zone 2 and Zone 3 or Zone 1 and Zone 3 Detectors Trigger Automatic Release</b> <b>Code: C14</b>	Y	Enable / Disable	Enable / Disable
<b>Zone 1 and Zone 2 and Zone 3 Detectors Trigger Automatic Release</b> <b>Code: C15</b>	Y	Enable / Disable	Enable / Disable
<b>Zone 1 or Zone 2 or Zone 3 Detectors Trigger Automatic Release</b> <b>Code: C16</b>	Y	Enable / Disable	Enable / Disable

Program Feature or Option	Permitted in UL 864 ? (Y / N)	Possible Settings	Settings Permitted In UL 864
<b>Zone 1 Triggers Automatic Release</b> Code: C17	Y	Enable / Disable	Enable / Disable
<b>Zone 2 Triggers Automatic Release</b> Code: C18	Y	Enable / Disable	Enable / Disable
<b>Zone 3 Triggers Automatic Release</b> Code: C19	Y	Enable / Disable	Enable / Disable
<b>Fire Buzzer</b> Code: C21	N	Enable / Disable	Enable
<b>Fire Output</b> Code: C22	N	Enable / Disable	Enable
<b>Trouble Output</b> Code: C23	Y	Enable / Disable	Enable
<b>Ground Trouble</b> Code: C24	N	Enable / Disable	Enable
<b>Pulse R0V Output</b> Code: C25	Y	Enable / Disable	Enable / Disable
<b>Remove AUX 24V On System Reset</b> Code: C26	Y	Enable / Disable	Enable / Disable
<b>Indicating Exting Released When Exting Output Is Active</b> Code: C27	Y	Enable / Disable	Enable / Disable
<b>No Activation Delay Upon Manual Release</b> Code: C28	Y	Enable / Disable	Enable / Disable

Program Feature or Option	Permitted in UL 864 ? (Y / N)	Possible Settings	Settings Permitted In UL 864
<b>Extinguishant Output Can Be Reset During Imminent Phase</b> Code: C29	Y	Enable / Disable	Enable / Disable
<b>Local Fire Relay Operates Upon Released Signal</b> Code: C2A	Y	Enable / Disable	Enable / Disable
<b>Extinguishing Output On Until Reset</b> Code: C2b	Y	Enable / Disable	Enable / Disable
<b>Low Pressure Switch Normally Closed</b> Code: C2C	Y	Enable / Disable	Enable / Disable
<b>Zone 1 Alarm From Detector Delayed</b> Code: C31	N	Delay Options 0 To 9	Option 0 to disable
<b>Zone 2 Alarm From Detector Delayed</b> Code: C32	N	Delay Options 0 To 9	Option 0 to disable
<b>Zone 3 Alarm From Detector Delayed</b> Code: C33	N	Delay Options 0 To 9	Option 0 to disable
<b>Zone 1 Alarm From Pull Station Delayed</b> Code: C41	N	Delay Options 0 To 9	Option 0 to disable
<b>Zone 2 Alarm From Pull Station Delayed</b> Code: C42	N	Delay Options 0 To 9	Option 0 to disable
<b>Zone 3 Alarm From Pull Station Delayed</b> Code: C43	N	Delay Options 0 To 9	Option 0 to disable

Program Feature or Option	Permitted in UL 864 ? (Y / N)	Possible Settings	Settings Permitted In UL 864
<b>Zone 1 Operates Through I.S. Barrier</b> Code: C61	N	Enable / Disable	Disable
<b>Zone 2 Operates Through I.S. Barrier</b> Code: C62	N	Enable / Disable	Disable
<b>Zone 3 Operates Through I.S. Barrier</b> Code: C63	N	Enable / Disable	Disable
<b>Zone 1 Short Circuit Indicates Alarm</b> Code: C71	Y	Enable / Disable	Enable / Disable
<b>Zone 2 Short Circuit Indicates Alarm</b> Code: C72	Y	Enable / Disable	Enable / Disable
<b>Zone 3 Short Circuit Indicates Alarm</b> Code: C73	Y	Enable / Disable	Enable / Disable
<b>Zone 1 Non-Latching</b> Code: C81	N	Enable / Disable	Disable
<b>Zone 2 Non-Latching</b> Code: C82	N	Enable / Disable	Disable
<b>Zone 3 Non-Latching</b> Code: C83	N	Enable / Disable	Disable

Program Feature or Option	Permitted in UL 864 ? (Y / N)	Possible Settings	Settings Permitted In UL 864
<b>Zone 1 Device Alarm Must Be Present For 30 Seconds</b> Code: CA1	N	0 To 30 Seconds	Option 0 to disable
<b>Zone 2 Device Alarm Must Be Present For 30 Seconds</b> Code: CA2	N	0 To 30 Seconds	Option 0 to disable
<b>Zone 3 Device Alarm Must Be Present For 30 Seconds</b> Code: CA3	N	0 To 30 Seconds	Option 0 to disable
<b>Panel Can Be Reset Immediately After Discharge Output Has Operated</b> Code: E00	Y	Enable / Disable	Enable / Disable
<b>Panel Can Be Reset 1 Minute To 29 Minutes After Discharge Output Has Operated</b> Code: E01 To E29	Y	1 To 29 Minutes	1 To 29 Minutes
<b>Panel Can Be Reset 30 Minutes After Discharge Output Has Operated</b> Code: E30	Y	Enable / Disable	Enable / Disable

Program Feature or Option	Permitted in UL 864 ? (Y / N)	Possible Settings	Settings Permitted In UL 864
<b>No Extinguishant Delay Code -00</b>	Y	Enable / Disable	Enable / Disable
<b>5 Second Extinguishant Delay Code: -05</b>	Y	Enable / Disable	Enable / Disable
<b>Increment Extinguishant Delay In Five Second Steps Code: -10 to -55</b>	Y	10 To 55 Seconds	10 To 55 Seconds
<b>60 Second Extinguishant Delay Code: -60</b>	Y	Enable / Disable	Enable / Disable
<b>Extinguishant Delay In 5 Second Steps Code: 60</b>	Y	0 To 60 Seconds	0 To 60 Seconds
<b>Increment Extinguishant Duration In Five Second Steps Code: 60 to 295</b>	Y	60 To 295 Seconds	60 To 295 Seconds
<b>Extinguishant Duration In 5 Second Steps Code: 300</b>	Y	60 To 300 Seconds	60 To 300 Seconds

# Index

## Numerics

1ST STAGE .....	17
1st Stage Alarm .....	52
24 VDC Terminals .....	63
2ND STAGE .....	17
2nd Stage Alarm .....	52
5.25 Amp Power Supply .....	9

## A

ABORT .....	17
Abort .....	7
Abort Connections .....	60
Abort Function .....	47
Abort terminals .....	60
Abort Trbl .....	36
AC Cabling .....	23
AC Input Fuse .....	68
AC Line Connection .....	68
AC Power .....	72
Access Level 1 .....	44
Access level 2 .....	44
Access Level 3 .....	38, 44
Access levels .....	44
ACT Relay .....	62
Activate Delays .....	51
Active Delays .....	45
Adding Status Units and Ancillary Boards .....	65
Amseco Compatible NAC Devices .....	84
Amseco NAC devices .....	83
anchor the empty cabinet .....	22
anchoring the HCVR-3 .....	22
Ancillary - HCVR-AB .....	78
Ancillary Board .....	61, 63
Ancillary Board - .....	78
Authorized Releasing Valves .....	96
Automatic-retry .....	9
AUX 24V .....	76
AUX 24V connection .....	33
Aux 24V Trbl .....	35
Auxiliary 24 VDC .....	103

## B

Batt Fail .....	35
Batt Low .....	35
Battery and Line Connections .....	72
Battery Capacity Equation .....	98
Battery Connection .....	72
Battery Fuse .....	55
Battery-backup .....	9
Battery-boost .....	9
before beginning the installation process .....	19
bridge rectifier input .....	22
bridge rectifier output .....	22

## C

cabinet door or enclosure-box .....	57
Cabling .....	77
Calculate the maximum current .....	103
Calculate the maximum wire length .....	103
Calculate the minimum operating-voltage .....	103
Calculate the minimum voltage .....	103
Calculate the voltage-drop of the circuit .....	103
Calibrate the releasing circuit .....	53
calibrating the releasing circuit .....	46
Class B, Style C field wiring .....	6
Cleaning the External Cabinet and Door .....	54
Close Extract Fan Contacts .....	45
common earth ground .....	61
Comms Trbl .....	35
Compatibility Identifier .....	80
Compatible Devices for Auxiliary 24V .....	96
Configuration Codes .....	39
Configuring .....	64
Connecting Data .....	63
connecting multiple Ancillary Boards .....	63
Connecting Power .....	63
Contacting Hochiki For Repair .....	1,3
Control Operation .....	45
conventional detectors .....	26
Cooper Industries Connection .....	29
Cooper/Wheelock Compatible NAC Devices .....	91
CPU Trbl .....	35
Current Draw From Battery In Mains Fail Condition ..	69
Current Draw Worksheet .....	98
Current loading calculations .....	98
Current-Loading .....	99

**D**

Deactivation Time	7
Denotes a displayed variable	3
Detection Zones	26
Detectors	80
Determining Battery Capacity	19
Determining the Amp-Hour Rating	98
DIP switch	64
DIP switch settings	65
DISAB Relay	62
Disable 1st Stage Contact	51
Disable 1st Stage Relay	44
Disable 2nd Stage Contact	51
Disable 2nd Stage Relay	44
Disable Extinguishant Release	45
Disable Extinguishant Subsystem	51
Disable Extract Fan	51
Disable Extract Fan-Relay	45
Disable Manual Release	45, 51
Disable NAC 1	44
Disable NAC Outputs	50, 51
Disable Trouble Contact	51
Disablements	49
Disablements / Supervisory	14
Document Conventions	1, 3
Double Zone Fire Condition	46

**E**

Earth Trbl	35
Electrical	68
electrostatic discharge	19
electrostatic discharge damage	19
Enable Access	11
End of Line Diode (EOLD)	31
Enter	11
EOL and Trouble Relay Connection	29
EOL resistor	26
example of the SRV circuit	106
external loads	68
Exting Trbl	36
EXTING.	17, 53
EXTING. MON	53
Exting. Mon.	12, 46
extinguishant release output	96
EXTR Relay	62
EXTRACT	17
Extract fan	49
Extract Relay	52

**F**

Fascia	8
Field Cabling	26
Field Terminal Capacity	73
Field Terminals	8
field terminals	16
Field Wiring	71
field-programmable software	136
Fire Protection Service Valve	103
Fire Protection Service Valves	9, 31
FIRE RELAY	17
Fire Relay	52
First and Second Stage Relays	7
Functions and Codes	44
Fuse failure	55
Fused, Electronic	74

**G**

General System Status	13
General Trouble	48
Gentex Compatible NAC Devices	86
Gentex NAC devices	83
Ground Strap	19
ground strap	19
Ground straps	19
Ground Trouble Indication	71
ground trouble indication	71
ground-faults	28

**H**

Halon 1301	32
Hochiki	80
Hold connections	60
Hold Input	61
HOLD Relay	62



**I**

IDC currents	98
If You Need Help	1
technical assistance contact	3
Improper connections	24
Indicates text displayed on a computer screen	3
Initiating Device Circuit (IDC) Ratings	73
Initiating Device Circuits (IDC)	26
Input (Supervised)	68
Inspecting Batteries	54
Installation	
Before you begin	19
Wiring AC Power and TELCO	23
Installing the 10 Amp Battery-Fuse	56
Installing the 3 Amp Power Supply Fuse	57
Installing the Standby-Batteries	55
Interconnected status units	7
internal power supply	9
Introduction	1

**K**

key-switch	49
------------	----

**L**

Lamp Test	11, 48
LOCAL FIRE	17
Local Fire Relay	52
Low Pres Trbl	36
LOW PRES. SWITCH	17
Low Pressure	7
Low Pressure Switch	48
low-battery indicator	54
Lower LED Indicators	15

**M**

Mains Fail	35
Mains Terminal Block	8
maintain and repair	54
MAN MODE Relay	62
MAN REL Relay	62
MAN. RELEASE	17
Manual Extinguishant Release	11
Manual Only Mode	7
Manual Release	32
Manual Release Switch	32

Manual Release Trbl	36
Maximum Current Draw	69
maximum current draw	100
maximum current-draw	102
Maximum line-voltage-drop	74
maximum load	28
maximum power rating	104
maximum resistance	101
maximum wire length	100, 103
maximum wire length (Lmax)	103
minimum operating-voltage	100, 102
Mode	11
Mode input	61
MODE SELECT	17
Mode Select	26
Mode Select Key Switch	61
Mode Trbl	36
Monitoring Circuit	32
Mounting	20, 22
Mounting Hardware	19
mounting site	19

**N**

NAC	100
NAC 1	73
NAC 2	73
NAC 3	30, 74
NAC Delay	7
NAC Extender PS-8 connection	30
NAC Extenders	28
NAC Outputs	9
NAC outputs	99
NAC Reactivation	7
NAC Trouble	48
Navigate the menu	38
NFPA	2
NFPA 72	26
no load conditions	68
nominal operating-voltage	104
nominal output-voltage	104
non-power limited	22
Notification Appliance Circuit (NAC)	28, 73
Notification Appliances	83

**O**

Operating Constraints	20
operating duration	70
Operating Environment	79
Operating Limits	33
Operating the Fire Control Panel	44
Outputs of NAC 1 and NAC 2	83
Overview	6, 18
Panel Controls and Indicators	9

**P**

Part Numbers	3
Appendix B	3
Part numbers	
Appendix B	3
Appendix D	3
Permitted in UL 864 ? (Y/N)	136
Physical Specifications	79
Planning	19
Possible Settings	136
Power cabling	23
Power circuits	99
Power Fault (PF)	64
power limited	22
Power Output Circuits	76
Power Outputs	9
Power Source Failure Function	7
Power Supply	68
Power Supply Primary, 115 VAC	69
Power Supply Primary, 230 VAC	69
Power Trouble	48
Power-Supply	9
Pre-discharge and Release Warnings	7
Preparation	38
Processor Reset	12, 46
Product Return Address	4
Program Feature or Option	136
Programming	38

**R**

Rechargeable Battery Circuit	70
recharging circuit	24
Regulated	74
regulated outputs	28
re-initialize processors	46
REL PRES. SWITCH	17
REL Relays	62
Related Documentation	1, 3
Relay Contacts	62
Relay Outputs	33
Relay Ratings	75
Release Trbl	36
Released Condition	48
Releasing Circuit	9, 31
Releasing Delay	7
Releasing Device Circuit	74
releasing devices	31
Releasing Inputs	74
Releasing Key-Switch	11
releasing notification appliances	30
Releasing Output Only	74
Releasing Outputs	75
Releasing Signal	7
releasing solenoids	31
Releasing Status	14
releasing-valve	103
Remote Control Inputs	26, 28, 76
Removing Status Units and Ancillary Boards	66
Removing the 10 Amp Battery-Fuse	55
Removing the 3 Amp Power Supply Fuse	56
Removing the AC Input Fuse	56
Removing the Standby-Batteries	54
replacement batteries	54
Replacement Parts	82
replacement standby-batteries	24
Replacing Fuses	55
Replacing Standby-Batteries	54
Reset	11, 47
Return Material Authorization (RMA)	4
RMA number	4

**S**

S1, S2 and S3 Trbl	36
Sample Lmax Calculation	100, 104
Select	11
Selecting Standby-Batteries	20, 98
Separation of Circuits	22
Settings Permitted In UL 864	136
Short Circuit Threshold	74
Short-circuit protection	9
Silence Buzzer	11
Silence/Sound Alarm	11
Silence/Sound Alarms	47
Single Zone Fire Condition	46
Solenoid Wiring	31
spacing	2
Special Application	73
special application	28
Standard for Control Units and Accessories for Fire Alarm Systems	136
Standby and Alarm Power-Limitations	69
Standby-Batteries	8
Standby-Battery Cabling	24
Standby-Battery Capacity	20
Standby-Battery Loads	70
Status	9
Status Unit - VF1821 Series	78
Status Unit Terminals	33, 77
Status Units	58
Style B	26
Style C	26
sum of device-loads	99
Supervised Inputs	26, 27
Supervision	74
Supervisory Signal Function	7
Supplementary Devices	78
Supporting Hochiki Equipment and Devices	81
Synchronization	83
Synchronization Modules	83
Sys Fuse Trbl	36
System Current Draw	20
System Power-Limitations	68
System Sensor	80
System Sensor Compatible NAC Devices	89
System Sensor NAC device	83
System Sensor NAC devices	83

**T**

Tell Tale	36
Terminate Release	12, 45
Test mode	49
Testing the Installation	23, 34
Testing the Releasing System	54
The J2 Jumper Connection	58
To complete the installation	18
total current	63
Total Maximum Current	70
Total standby-current	71
total-current-loading	99
Transfer Voltage	68
TROUBLE RELAY	17
Trouble Relay	52
Troubleshooting	35

**U**

UL 864 Permitted Configurations	136
UL Compliance Label	134
UL Listing Requirement	84, 87, 89, 92
used for emphasis	3
Using This Manual	1, 2

**V**

variable that you must type	3
Voltage Free Relay Contacts	7

**W**

W / Dog Reset	12, 45
Warranty Returns	4
Wheelock NAC devices	83
Wiring Diagram	108
Write Enable	12, 46
Writing styles	3

**Z**

Zonal Fire Relays	62
Zone Testing	7
Zone Trouble	48

This page intentionally left blank.



Hochiki America Corporation  
7051 Village Drive, Suite 100  
Buena Park, CA 90621-2268  
Corporate Headquarters: 714.522.2246  
Technical Support: 800.845.6692  
<http://www.hochiki.com>

Document: HA-06-294  
Version:V02.10  
Issue Date: 25 Jan 2013